

The image features a solid blue background. Two white, thin, curved lines arc across the page, one above and one below the central text. The upper arc starts with a white star on the left and ends on the right. The lower arc starts on the left and ends with a white star on the right. The text 'Hudl User Guide' is centered in a white, sans-serif font.

Hudl User Guide

Contents

		11	Unlocking Security	22	Panning
		12	Sleeping Switching off	23	Portrait or landscape viewing
4	Introduction	13	Sound	24	Quick access, status and settings
5	What can I do with Hudl?	14	Docking a micro-SD card	25	Home page
6	Unpacking Carton Contents	15	First use	27	Home page apps
7	Controls and Connections	17	How does the touchscreen work?	28	Home page wallpaper
8	Portable/Mains operation Battery level indication	18	Entering text or numbers	29	Apps
9	Connecting power	19	Typing with Swype Correcting text	30	Launching an app Moving home page apps
10	First charge Battery care	20	Entering text by speaking	31	Getting more apps
11	Switching on	21	Zoom	32	Adding or removing Home page apps
				33	Widgets

Contents

35	Browsing the Internet	62	Viewing your photos and videos	75	Troubleshooting
38	YouTube and social networking	64	Backing up your data	77	Specifications
39	Email	65	Device settings > Overview	78	For further reference...
45	The Tesco App	66	Device settings > Wireless and networks		
46	Using the camera	68	Device settings > Device		
51	Clock application	70	Device settings > Personal		
57	Music, photos and video	72	Device settings > Accounts		
58	Transferring files using Windows Explorer	73	Device settings > System		
61	Playing Music	74	Connecting accessories		

Introduction

Congratulations on the purchase of your Hudl.

Hudl is fully portable, and powered by an internal rechargeable battery. The supplied charger can fully charge it in 3 hours.

It includes built in wi-fi to connect to your wireless network and bluetooth to connect to suitable headphones, speakers and other accessories.

Hudl includes 16GB of flash memory, most of which is available for your data. A micro-SD port enables you to dock a micro-SD card and expand the memory available further by up to 32GB.

This user guide will help you understand how to interact with Hudl and how it will respond to your actions.

It will also provide you with instructions for some of the more popular apps that are bundled with Hudl, and help you to understand the settings that you can change.

However, this is just the start of the story, you can personalise Hudl by adding more applications from the store or just by downloading media that you like.

What can I do with Hudl?

If you have access to the Internet via a Wi-Fi connection you can use it to stay in touch through email and social networking, you can search the Internet or browse for videos on Youtube.

You can load your choice of music, digital photos, movies or e-books into the built-in memory which can be expanded if required.

Once your files are loaded you can play music*, browse photos* read books* or watch movies* on the 7" display screen. You can choose to play sound through the built-in speakers or connect a pair of headphones (not supplied).

*Compatible file formats only.

The touch-sensitive screen will zoom in and out and will display full qwerty or numeric keyboards when text or number entry is required.

Quick links on-screen enable you to easily switch between screens you have recently used or to return to the Home page.

The dual built-in cameras enable you to take photos or videos and also to make video phone calls or messaging (suitable applications will be required).

In addition, many compatible gaming, leisure or business applications are available and can be ordered and installed directly from the online store.

Hudl comes pre-loaded with useful Tesco apps that can help you shop online, browse blinkbox for movies and music or manage your Clubcard account.

Unpacking

Carefully unpack the unit. If it is damaged, please return it to your nearest Tesco store for replacement. Remember to take your purchase receipt with you.

Retain the Quick Start Guide and Safety and legal information sheet. If you pass the unit on to a third party make sure you pass on these items.

We suggest you retain the packaging. If you dispose of it, do so having regard to recycling regulations in your area.

Carton contents

The carton should contain:

- Hudl
- AC adaptor/charger
- Micro-USB cable
- Quick Start Guide
- Safety and legal information leaflet

If any items are missing or damaged, contact your nearest TESCO store for a replacement. Have your receipt ready when you call. Retain the packaging. If you dispose of it, do so having regard to recycling regulations in your area.

Controls and Connections

- 1 HDMI outlet. Connect to an HDMI TV to view movies and photos with a suitable cable (not supplied).
- 2 Front camera.
- 3 Headphone socket. The speakers are switched off when headphones are connected.
- 4 Sleep/Power button.
- 5 Volume control.
- 6 Micro-SD card slot. Dock a micro-SD card into the slot to expand the memory for your media.
- 7 USB/charging connector.



Portable/Mains operation

When fully charged, Hudl will operate from an internal battery, or can be powered and charged from the mains by the supplied AC adapter.

Battery level indication

The battery level indicator is shown in the status area in the top, right corner of the screen.

The battery level is shown in the battery symbol. The blue level in this example shows half-charge.

The flash shown in the example will appear when the battery is charging.

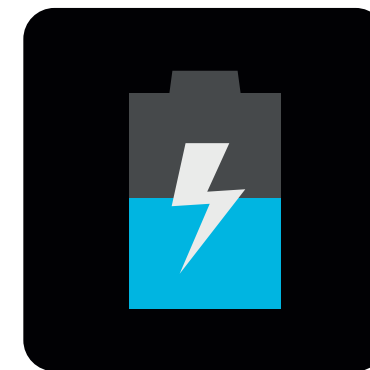

Connecting power

- 1 Plug the USB cable into the USB port on the AC adapter/charger.
- 2 Connect the cable to the micro-USB port on the Hudl.
- 3 Check that the mains voltage marked on the rating plate of the AC adapter/charger is the same as the voltage in your area.
- 4 Plug the AC adaptor into an AC outlet and switch the mains power on.

Hudl will start to charge.

You can use Hudl while the charger is connected.

Note Hudl will also charge when connected to a computer via a USB connection.

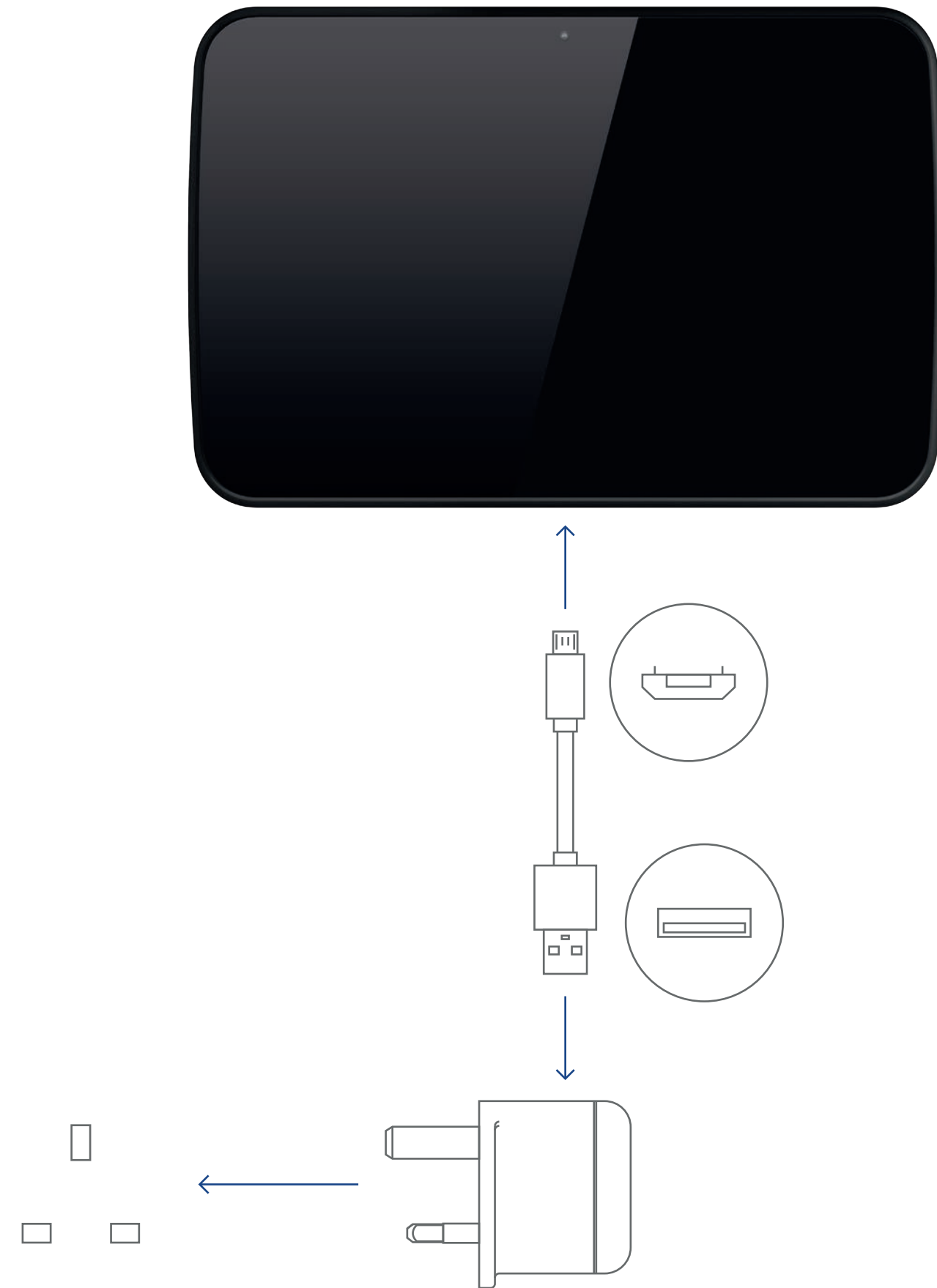

First charge

Ensure that you have enough time available (approximately 3 hours) to fully charge the battery when you connect the charger for the first time.

Battery care

To ensure maximum life from the battery in your Hudl, follow these guidelines:

- Discharge the battery completely twice a year.
- If it hasn't been used for a long period of time, discharge the battery completely, then fully charge it for 8 hours before use.
- Never charge Hudl for more than 24 hours.
- Never recharge the battery below 0°C.
- Avoid recharging the battery in direct sunlight or near a radiating heat source.

Switching on

- 1 Press the Sleep/Power button briefly to switch Hudl on after sleeping.
- 2 Press and hold the Sleep/Power button to switch Hudl on when powered off.

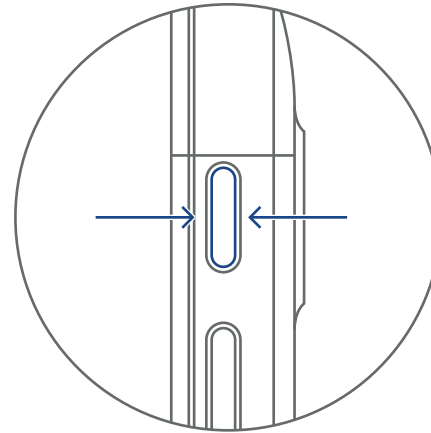
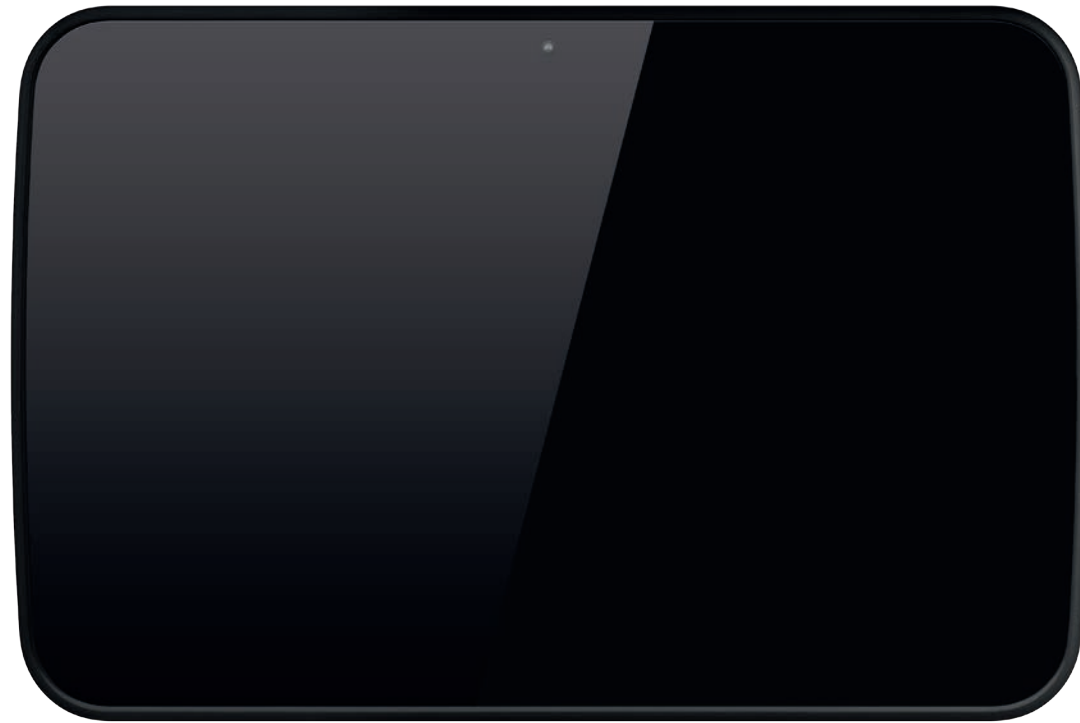

The display will light and show the lock icon on-screen.

Unlocking

- Touch the lock icon and slide the circle across to the unlock icon.

Hudl will unlock and the display will show the last screen you used.

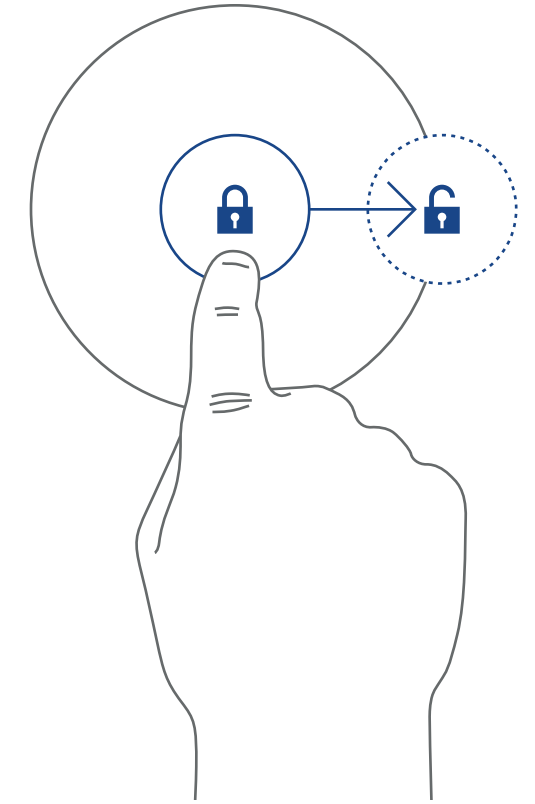

Security

You can set a security setting to protect Hudl from unauthorised access. Choose from face recognition, a password, a PIN, or a pattern. Once you have familiarised yourself with the operation of Hudl, refer to Personal > Security > Screen Security in the security settings section of these instructions on page 70 for more details about setting up security.

Sleeping

When set to sleep, Hudl will wake up again quickly when needed. Sleep mode is recommended when Hudl is in regular use.

- Press the Sleep/Power button briefly to put the tablet into sleep mode.

Hudl will sleep.

Switching off

If the power is switched off completely, Hudl will save battery power, but will take longer to wake up.

- 1 Press and hold the Sleep/Power button to switch off.

*You can now choose **Power off**, **Aeroplane mode** or **Silent mode**.*

- 2 Choose **Power off** to switch off and save power.
- 3 Choose **Aeroplane mode** to keep running, but switch off wireless network and bluetooth communication.
- 4 Choose **Silent mode** to keep running, but with the sound muted,

Auto Sleep

Hudl will automatically sleep if you haven't touched the screen for a while. You can change the Auto Sleep period if required. Refer to the Settings section for more information.

Sound

Hudl includes stereo sound from speakers on the back panel.

Volume control

- Set the volume by adjusting the volume control on the right side, below the Sleep/Power button. Press the top of the control to increase the volume, press the bottom to reduce the volume.

Headphone listening

- Connect headphones to the headphone socket on the top edge.

When headphones are connected for private listening, the sound from the speakers will be muted.

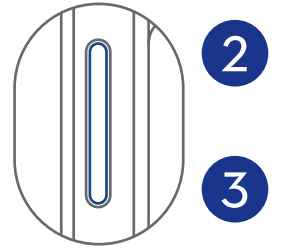
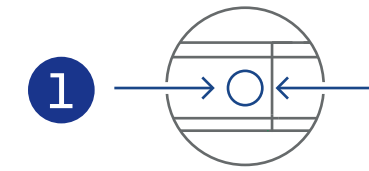

2

3

- 1 Headphone socket
- 2 Increase volume
- 3 Reduce volume

Docking a micro-SD card

You can dock a micro-SD card to add up to 32GB additional memory storage to Hudl.

- 1 Before docking the card, switch the power off as described in the previous section.

- 2 Insert the micro-SD card into the port.

The micro-SD card is polarised so must only be inserted as shown in the diagram.

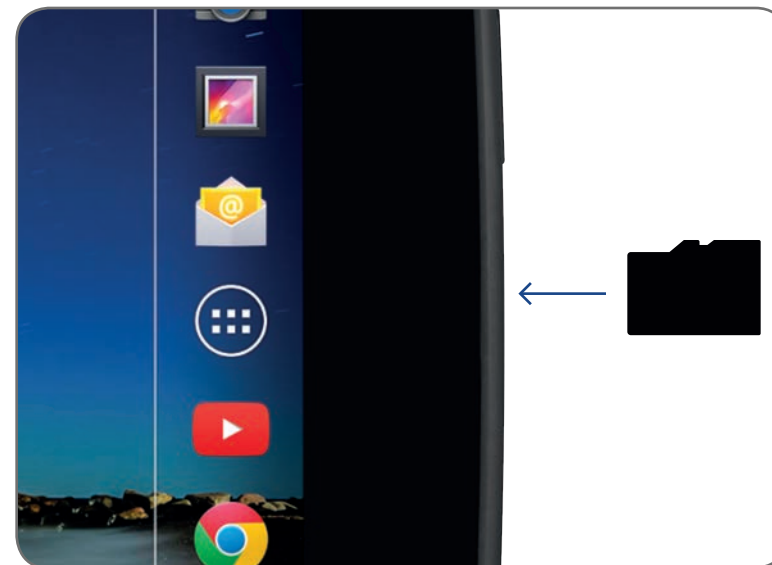

- 3 Press the micro-SD card into the port until it clicks into place.
- 4 Switch on the power.

You can now use the expanded memory on your micro-SD card.

Removing a docked micro-SD card:

Caution You may have applications, data and media files stored on a micro-SD card. These will not be available for if you remove the card.

- 1 Before removing the card, switch the power off.
- 2 Press the tip of the micro-SD card.

The micro-SD card will pop out of the dock slightly.

- 3 Remove the card from the dock.
- 4 Switch on the power.

First use

When you first power up Hudl, the Installation wizard will run. This will help you step through the initial settings you need to choose to get set up.

The settings sequence is shown here.

1 Language

Choose your preferred language for the display.

2 Select Wi-Fi

Hudl will list all available Wi-Fi networks.

3 Choose your network and enter the access password.

If you encounter any problems connecting to your Wi-Fi network, refer to the section [Device Settings > Wireless & Networks](#) on page 66 for more information.

4 Google account

Sign in to your Google account or create one.

5 Google & location

Choose to enable apps to use your location.

6 Date & time

The Date and time will be displayed. The time should already be set through the Internet connection. If the information displayed is incorrect or if there is no Wi-Fi connection available, correct the settings if necessary.

First use (continued)

7 This tablet belongs to...

Enter your name as the owner of Hudl.

8 Google services

Read the privacy policy and other terms before proceeding.

9 Setup complete

The installation wizard has completed successfully.

10 Add a Tesco account

If you have a Tesco account, you can enter the details now for use with Tesco apps.

Follow the prompts to enter your account login and password.

How does the touchscreen work?

The touchscreen is a dual purpose interactive display and input device. No keyboard or mouse is required to open apps or write text.

1.



Changing screens or moving items

You can slide your finger across the screen to change screens or move items.

2.

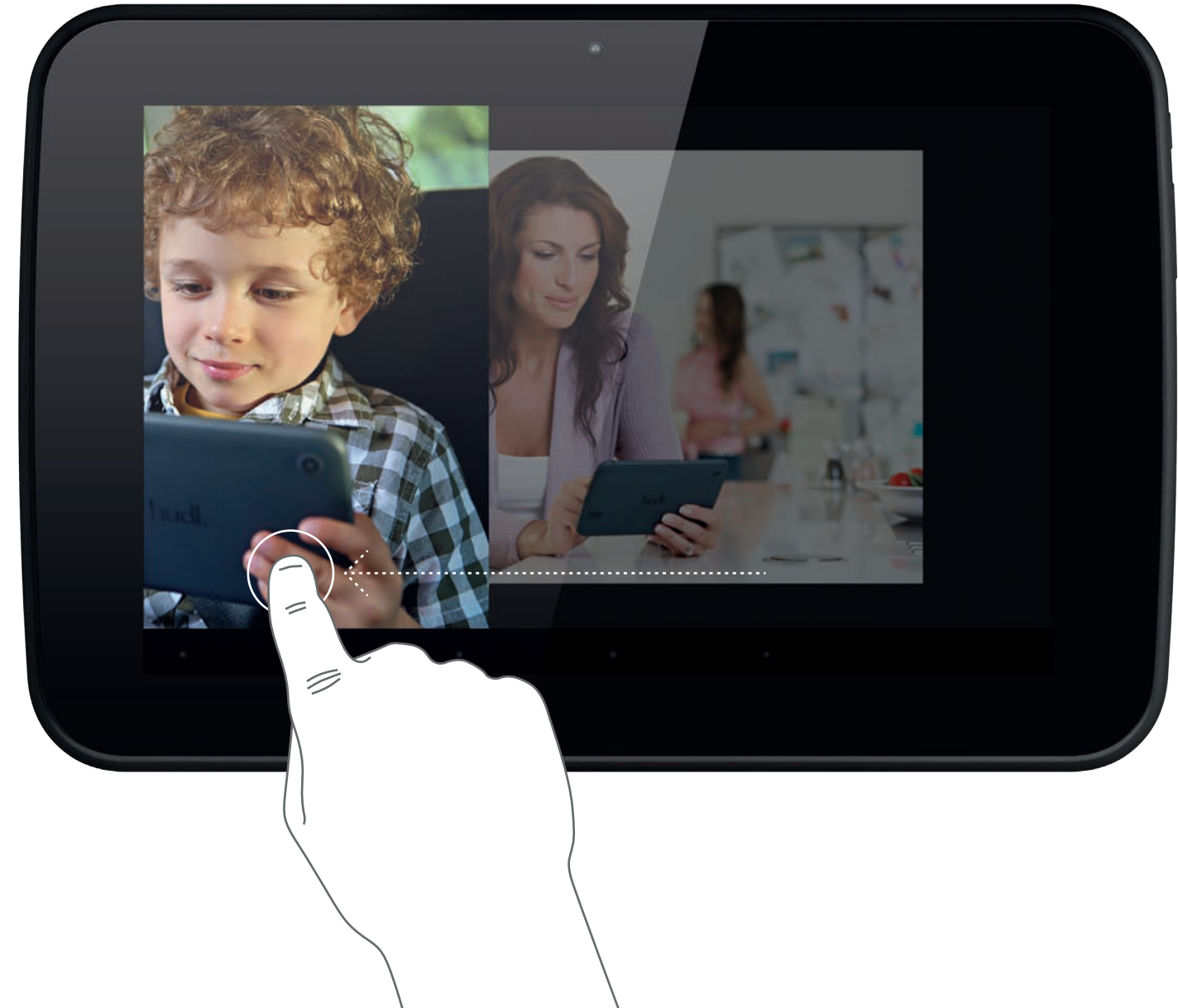

Entering text or numbers

When you need to enter text or numbers a qwerty keypad will appear on screen.

Typing

- You can touch type on the keypad.

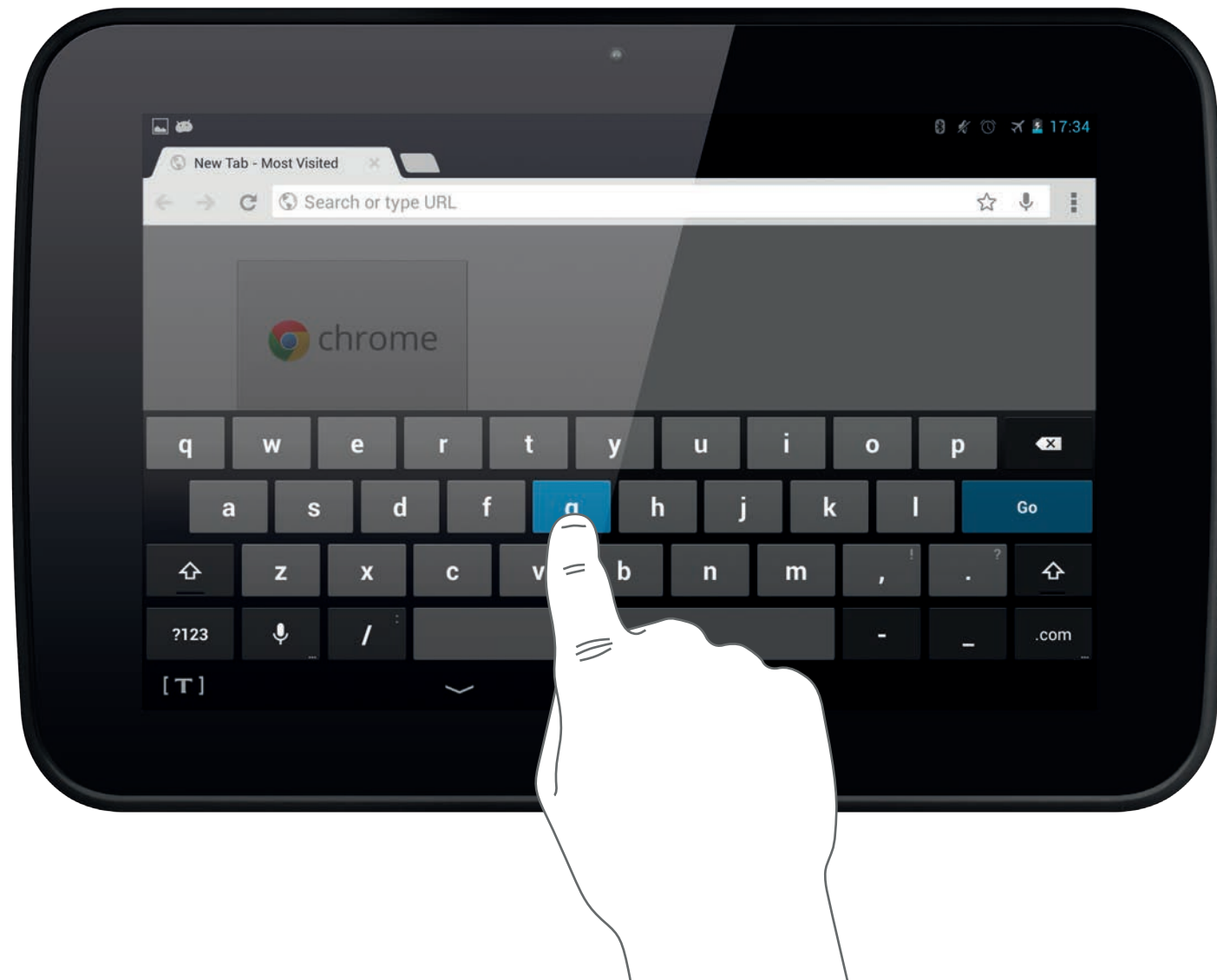

Upper and lower case

- Touch the Shift key ↵ on the keyboard to type a single capital letter.
- Touch and hold the Shift key ↵ to turn on capslock, this allows you to type all capital letters.

Switching between the text and numeric keypads

There are three keypads: qwerty, numeric/punctuation and additional punctuation.

- From the text keyboard, touch the **?123** key to switch to the numeric/punctuation keyboard.
- From the numeric/punctuation keyboard, touch the **~/{** key to switch to the additional punctuation keyboard or...

... touch the **ABC** key to return to the qwerty keyboard.

Typing with Swype

It's also possible to type using Swype on Hudl.

When entering text there is no need to lift your finger from the screen, just glide slowly from letter to letter. You may find using Swype is quicker than touch-typing.

Glide your finger across the letters **w—e—d—i—n—g** Hudl will detect you are typing wedding and will enter the word for you, adding in the double d.

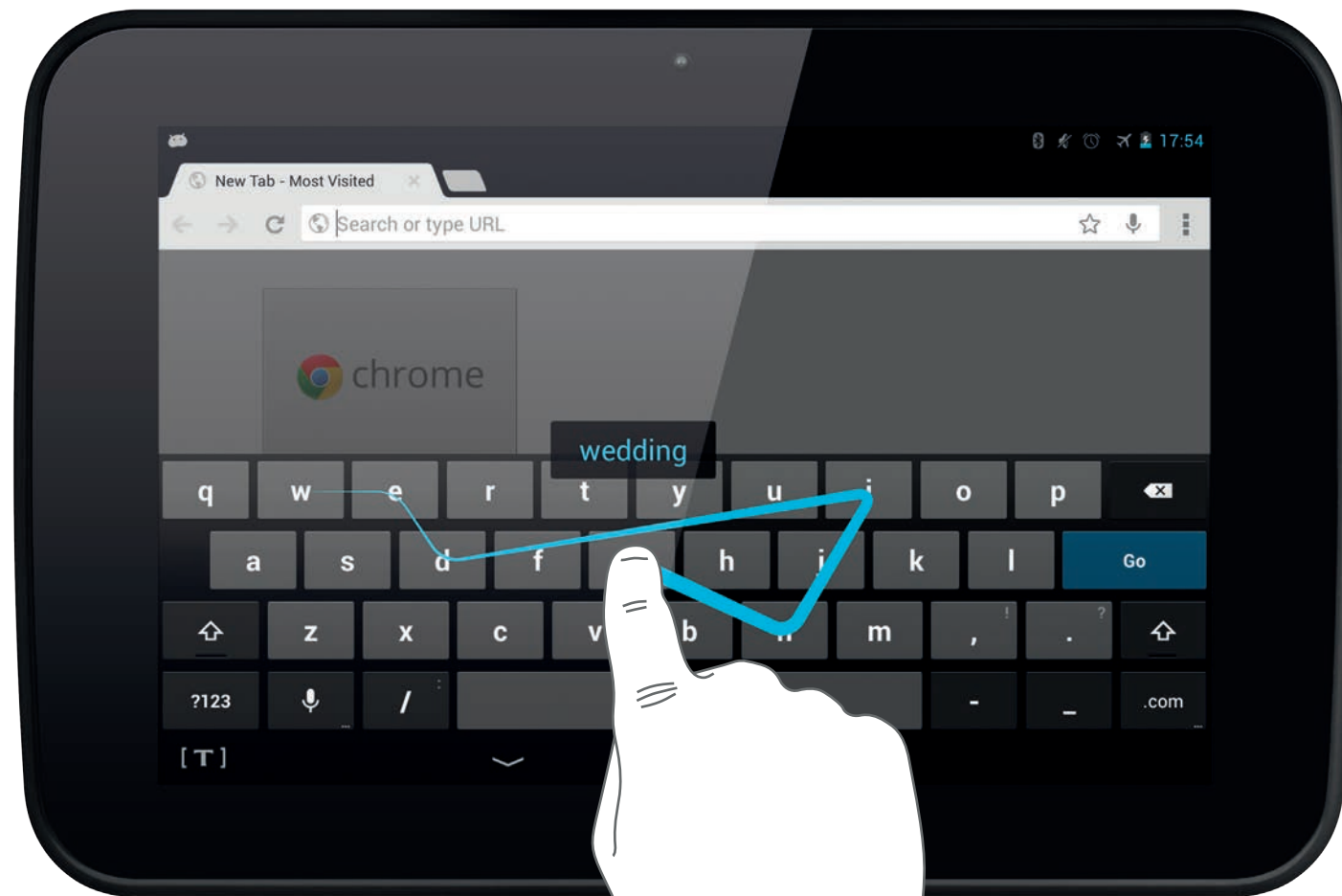

Correcting text

Occasionally, you may want to correct the text entered in a text entry box.

Correcting a letter

- 1 Touch the text you are entering. *A pointer will appear as shown in this Internet search example.*
- 2 Slide the pointer to the place you want to correct.
- 3 Correct the text.

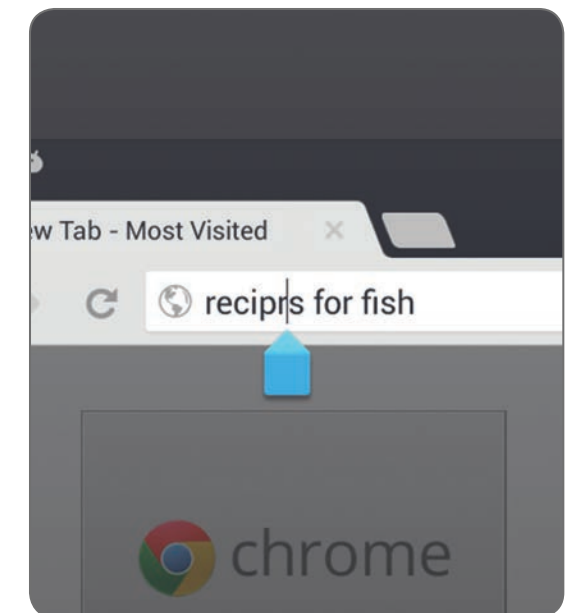

Correcting a word

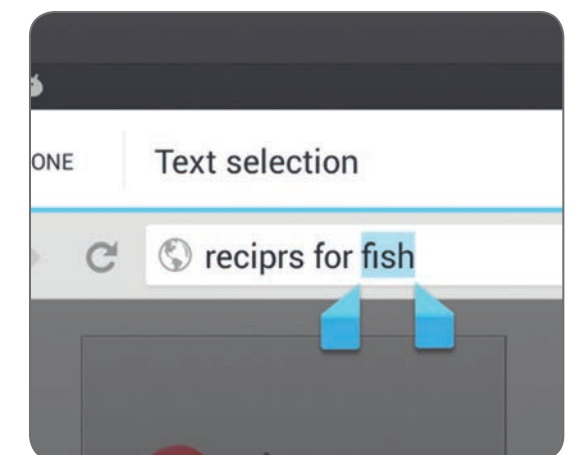

- 1 Touch and hold the word you want to correct. *The word will be highlighted.*
- 2 Correct the word.



Entering text by speaking

You can also enter text by speaking.

Whenever the  icon is displayed you can use your voice to enter text instead of using the keyboard.

The  icon will usually be displayed when a qwerty keyboard is available for text entry and also in some applications. For example, the  icon will appear when searching the Internet using Google Chrome.

- 1 Touch the  icon to activate speech entry.
- 2 Speak slowly and clearly.

When you pause, your speech will be analysed and the translation will be added to the text box with an underline.

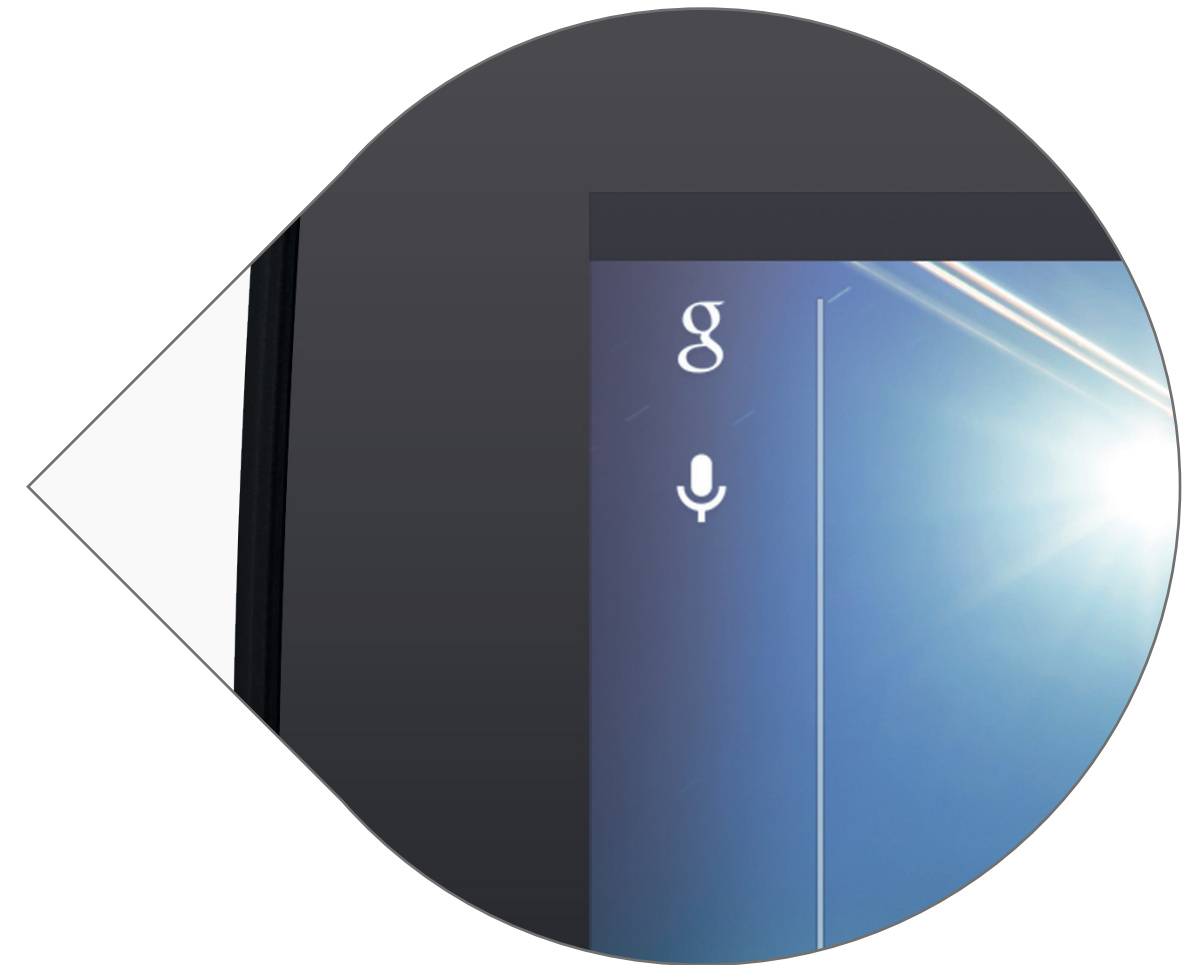

Zoom

When using certain apps, for e.g. Chrome for internet browsing or Gallery for viewing your photographs, you can enlarge or shrink the contents of the screen using a single gesture, this is useful if you'd like to view details within the content.

Zoom in

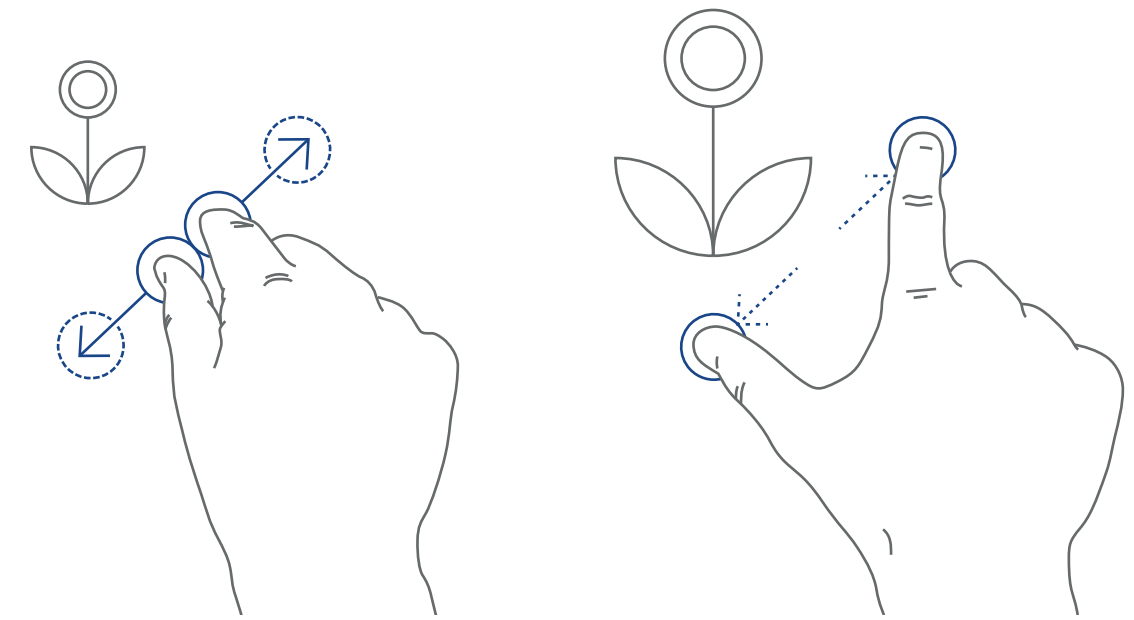

Place two fingers on the screen and spread them apart to zoom in.

Zoom out

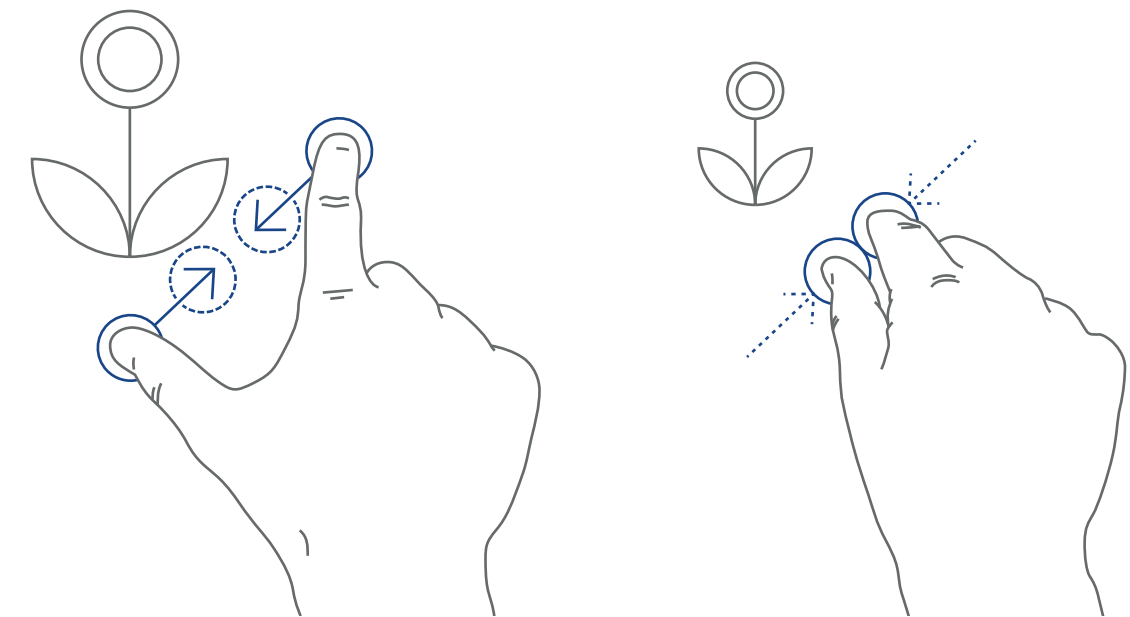

Place two fingers on the screen and pinch them together to zoom out.

Panning

Once you have zoomed in you can move/pan around the content using a single finger slide.

Panning

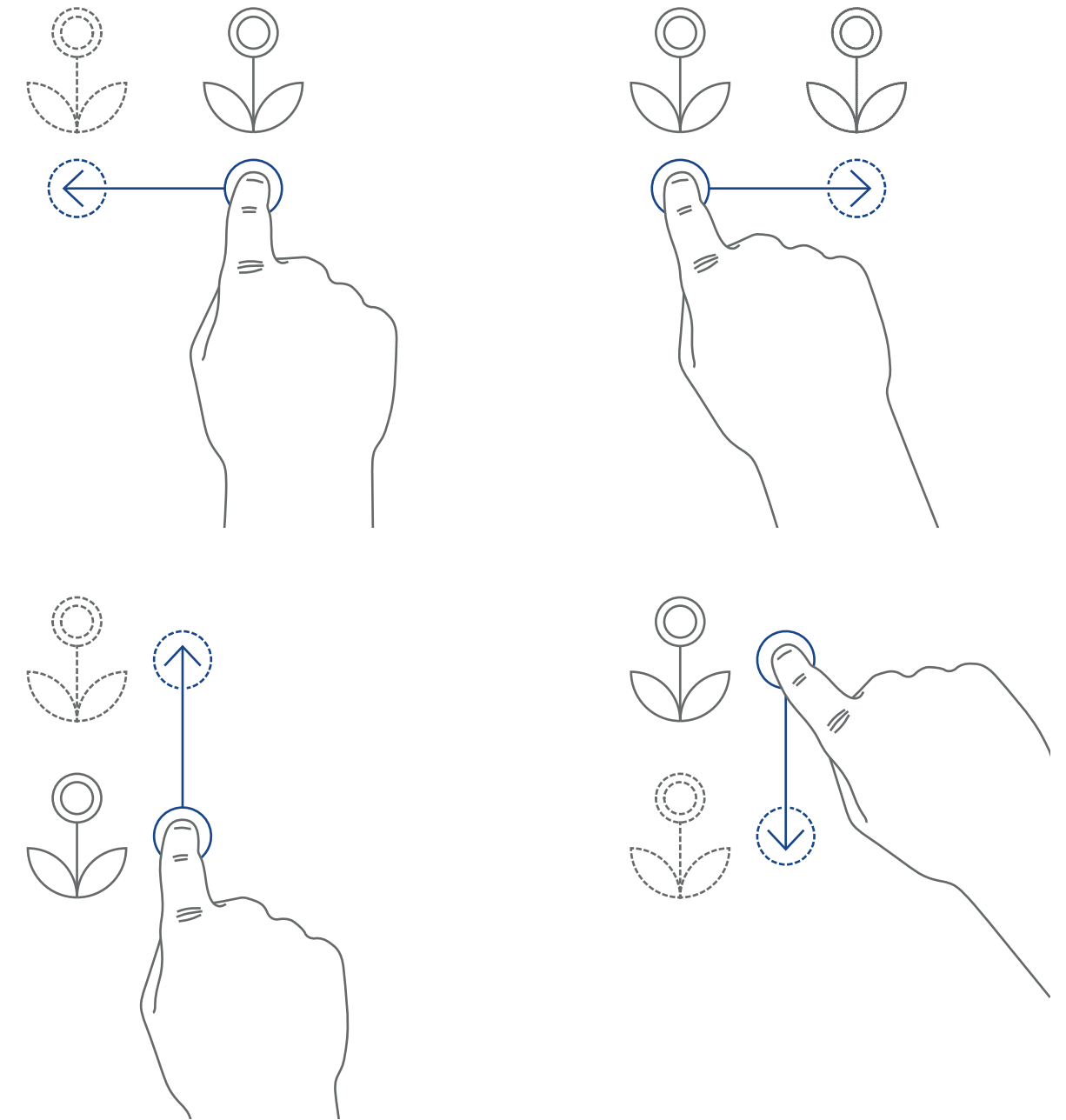

Place a single finger on the screen and slide it in the direction you want to pan.

The content will move in that direction.

Portrait or landscape viewing

At any time you can use the tablet in either portrait or landscape format.

**Portrait
/Landscape**

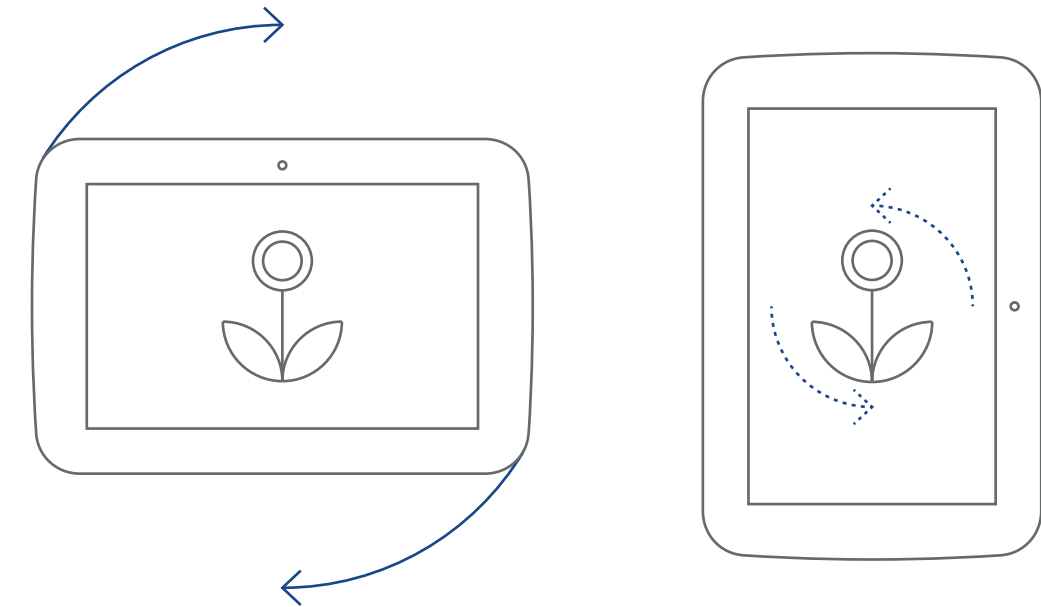

Rotate the screen to switch between portrait and landscape view.

The accelerometer will detect which way you are holding the screen and rotate the content on the screen accordingly.

Documents and photos of people may display best in portrait view whilst movies and photos of groups and scenes are best displayed in Landscape view.

Quick access, status and settings

To Open

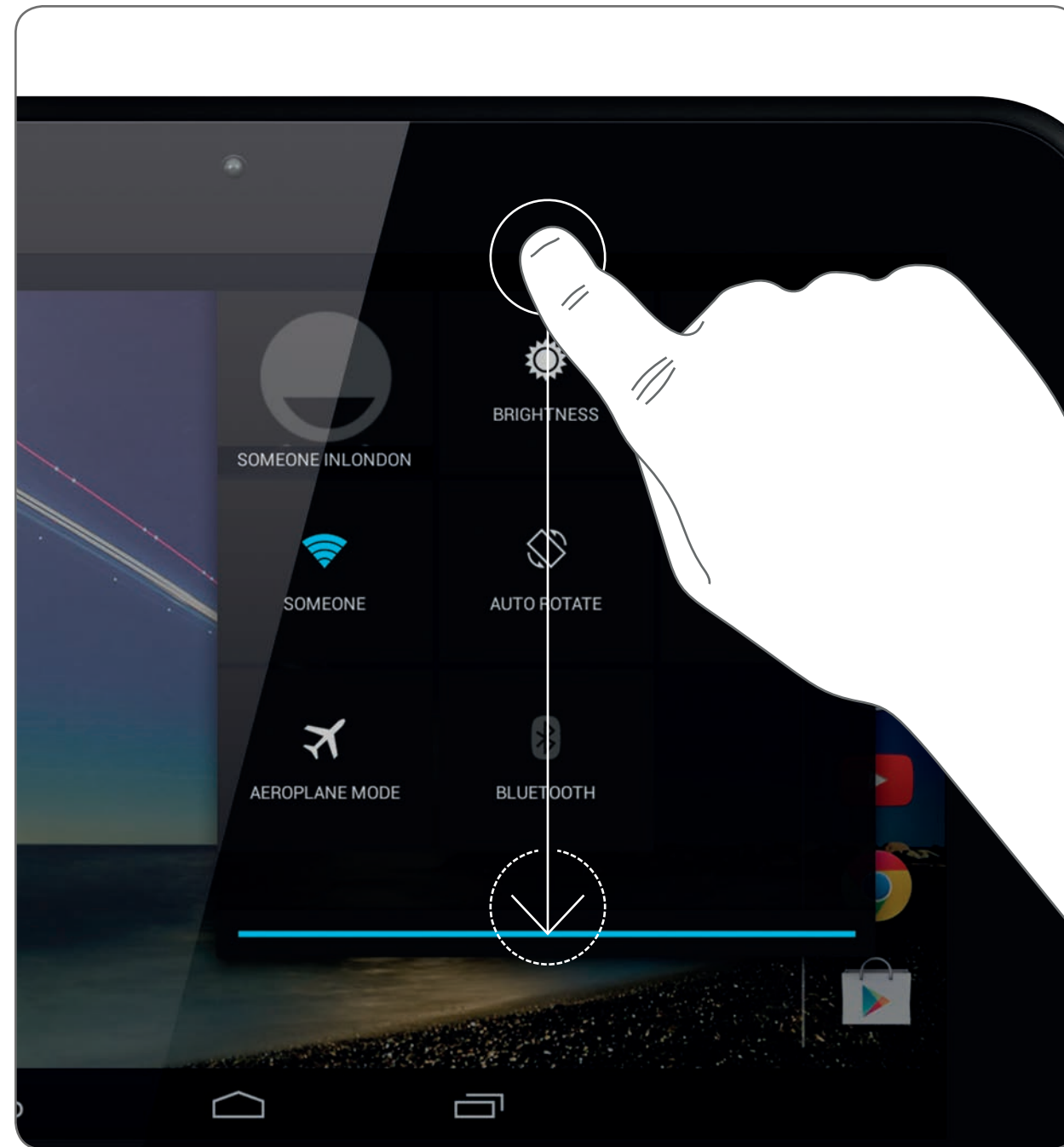

Slide a finger down near the right-hand corner of the screen to open the status and settings pane.

Further Actions

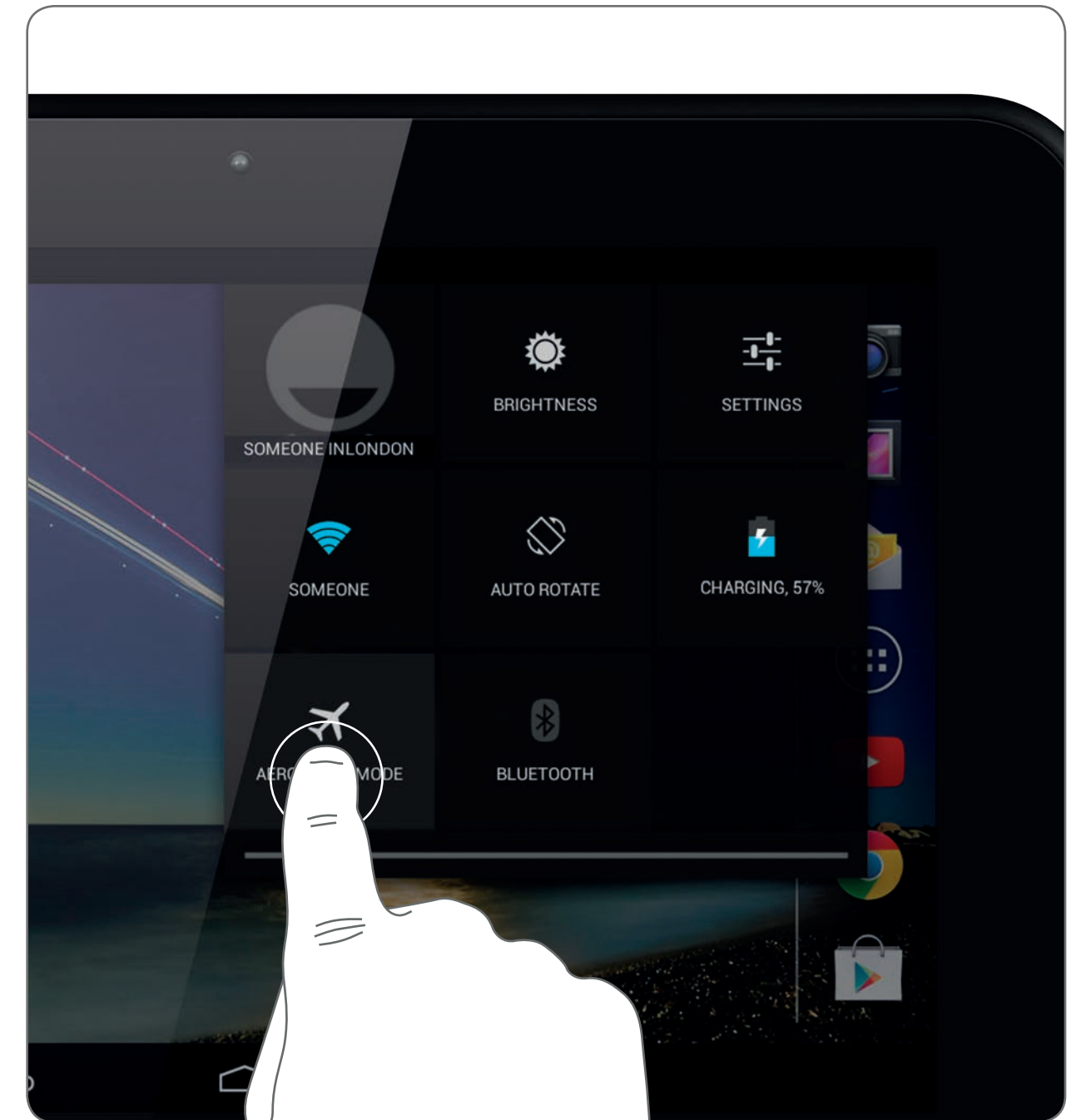

Touch any of the icons for more status information or to change any of the settings shown.

Home page

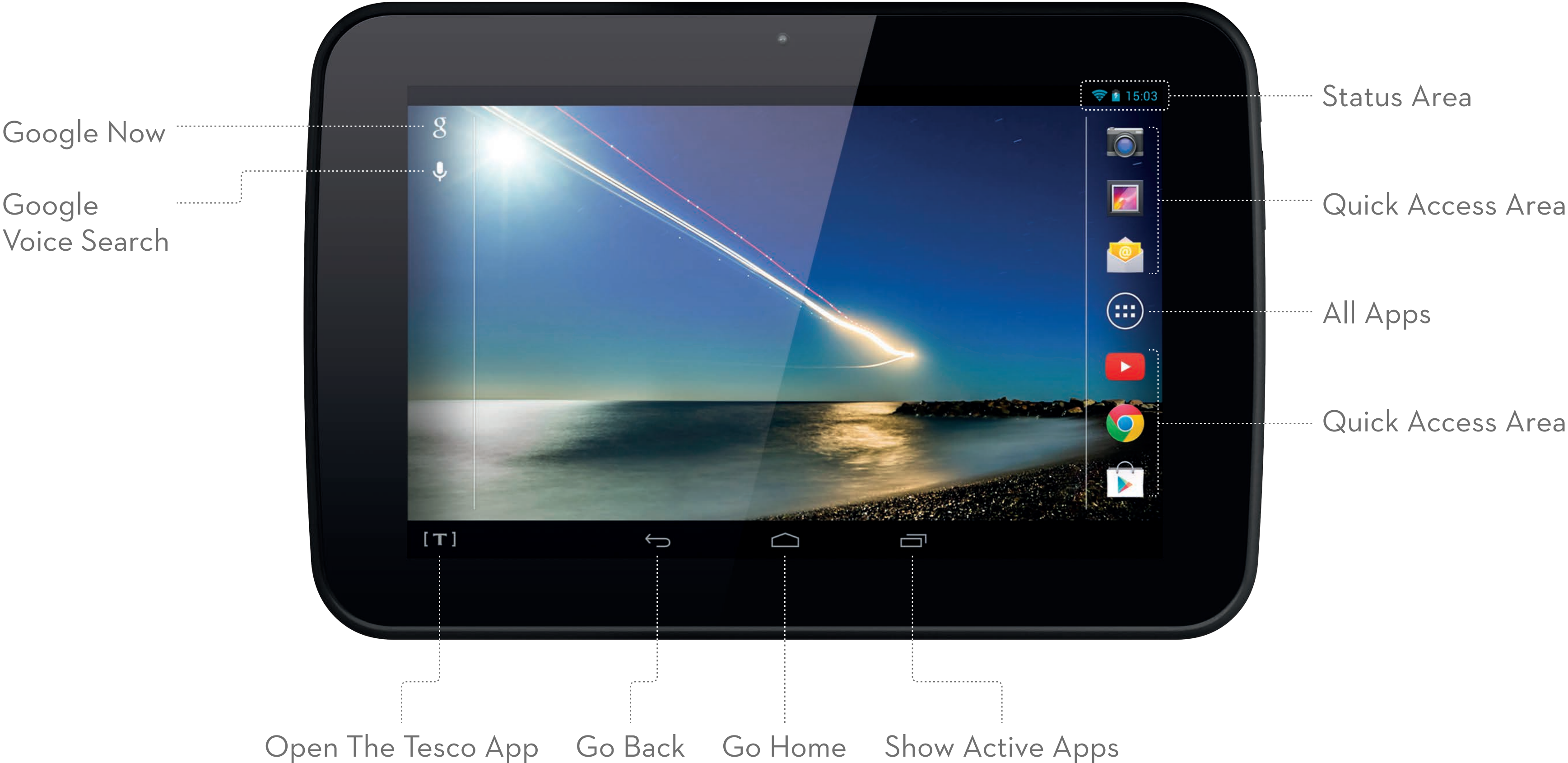

Home page

Google Now Google Search, combined with information and updates tailored to you, these cards are based on your habits, location and preferences (requires you to have a signed in Google Account enabled on the tablet).

Google Voice Search Search the internet and the tablet using spoken natural language instead of a traditional text based search.

Tesco Order groceries, find recipe inspiration, manage your Clubcard, shop with Tesco Direct or F&F Clothing, check out the offers and services from Tesco Bank, browse blinkbox movies and music, and find your local Tesco all in one app.

Back Go back a page.

Home Go to the Home page.

Active Apps View and switch between active apps.

Status Area Shows the status for bluetooth, Wi-Fi, set alarms, battery charge and the time.

Quick Access Area Six apps or folders of apps that appear on each of the five Home pages, which apps are displayed in this area may be customised to apps of your choosing. See Page 30 for further instructions.

All Apps Opens the App and Widget Library.

Home page apps

Hudl comes with a selection of useful apps pre-installed. These can be accessed by touching the All Apps icon.

The Quick Access Area, on the Home page, features six apps that we think you may find useful and enjoyable.



Touch the Camera app to take a photo. See page 46 to learn more about taking photos with the camera app.



Touch the Gallery app to view your photos. See page 62 for more details of viewing photos in the photo gallery.



Touch the Email app to send and receive email. See page 39 to find out how to set up an email account and use Hudl to keep in touch via email.

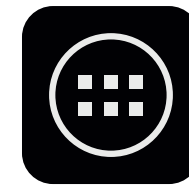

Touch to see your app and widget library. See page 29 to understand more about customising your Home page and installing, removing and managing apps.



Touch to launch YouTube and browse for your favourite videos online.



Touch Google Chrome to search and browse the Internet.



Touch Google Play to visit the store.

Home page wallpaper

A wallpaper is the picture displayed in the background of your home page. You can change the wallpaper to an image of your choice, one of your own photographs or one of the preloaded wallpapers.

To change the wallpaper

- 1 Touch and hold the screen in an area where there are no app icons.

The Choose wallpaper pane will open.

- 2 Choose either **Gallery** to use one of your own images, **Live Wallpaper** gently moving, preloaded wallpapers or **Wallpaper** static, preloaded wallpapers.
- 3 Select a new wallpaper.

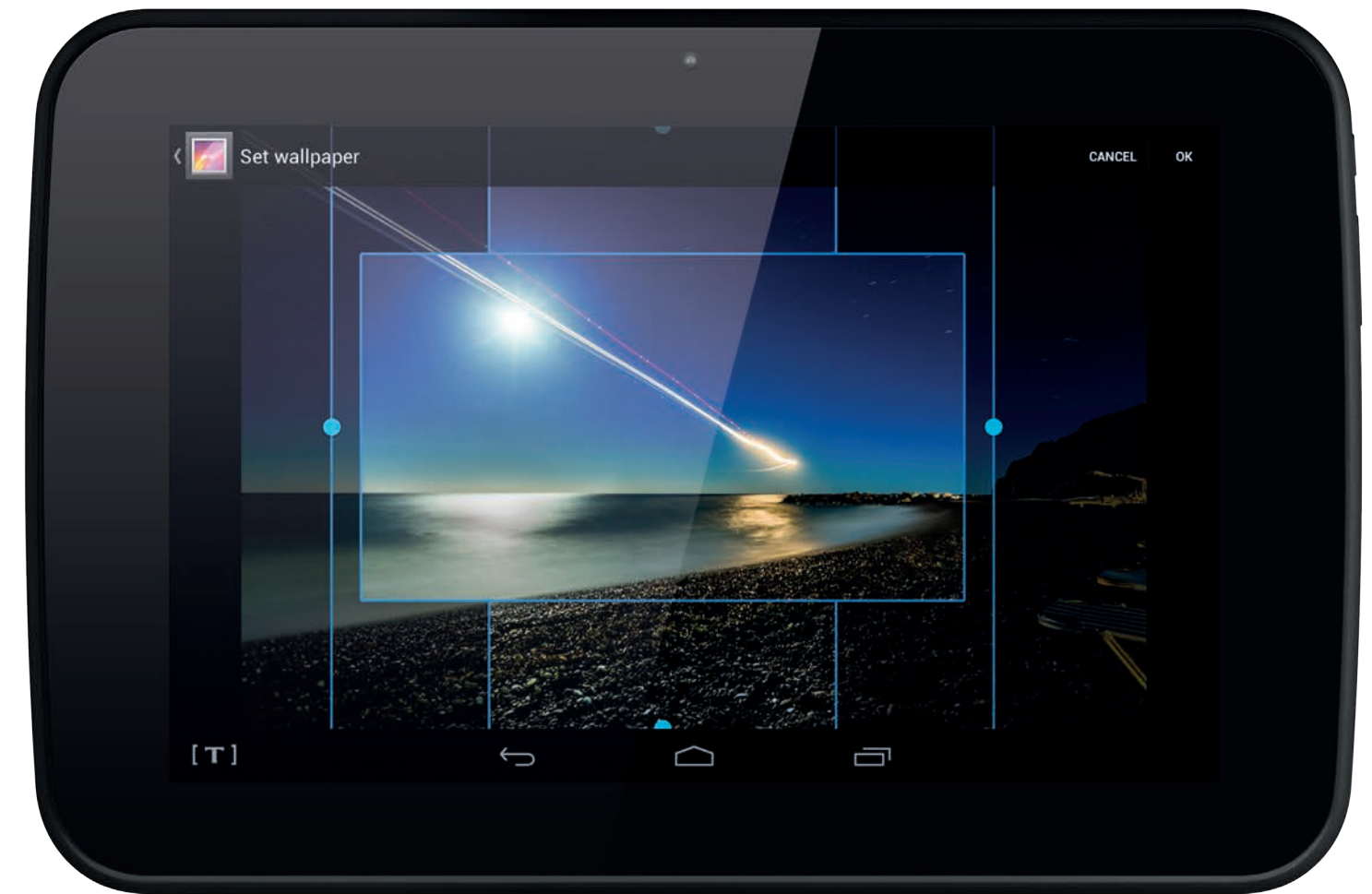

- 4 If you selected **Gallery**, two blue rectangles will appear, marking the areas of the photo that will be used for portrait and landscape wallpaper.
- 5 You can resize and reposition the template using the handles shown on each side of the template.
- 6 Once you are happy with your new wallpaper, touch **OK** in the top right corner of the screen.
The picture will now be set as your wallpaper.

Apps

Hudl is preloaded with a selection of apps, the supplied apps may vary, but include:

- An internet browser
- An email app
- A photo viewers
- A music and video players
- A map app
- A navigation route finder

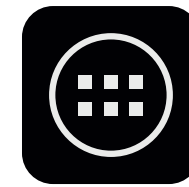

Touch the All Apps icon, located on the Home page, to view your app and widget library.

The All Apps screen will be displayed.

If you install more apps, they may be spread across several screens.

Slide the screen to the left or the right.



Launching an app

To launch an app

- 1 Touch the app icon on the screen.

The app will launch.

- 2 Apps normally have interactive on screen instructions that will help you understand how to use the app.

Moving home page apps

If you want to change the position of an app on the Home Page

- 1 Touch and hold the app.

- 2 Drag the app to a new position.

If you drag an app beyond the Home page, another page will be revealed.

Getting more apps

Each person will have different requirements and uses for their Hudl. To personalise your Hudl with the apps you want you can visit the Google Play store online and browse for more apps.

Note You can only visit the Google Play store if you have an active Wi-Fi connection.



Touch the Google Play app icon on the Home page.

You will be asked to sign in with a Google account. If you don't have a Google account you can select the option to set one up (there is currently no charge to set up a Google account).

Once your account is set up you can go straight to the shop and choose a category to browse.

Remember to fully explore the pages by dragging pages up, down and sideways. The category index will often be found by scrolling the pages to the right.

*There are often free apps available if you touch the **Top Free** tab at the top of the page.*

Adding or removing Home page apps

You may want to add your regularly used apps from the All Apps screen to your Home page for quick access.

To add an app to your Home page

- 1 Navigate to the All Apps screen.
- 2 Touch and hold the app icon you want to add to your Home page.

The app will be added to your Home page.

Removing apps from the Home page:

- 1 Touch and hold the app icon.
- 2 Drag the icon over the ✕ that appears at the top left of the screen.

The icon will be removed from the Home Page, but will remain on your tablet.

Permanently removing an app

- Refer to the instructions under ‘Device settings > Device > Apps’ on page 69 to completely uninstall an app.

Widgets

Hudl is bundled with many useful widgets including quick links to apps that you may use regularly.

To browse the widgets that are available

- 1 Touch the All Apps icon, located on the Home page, to view your App and Widget library.
- 2 Touch the **WIDGETS** tab in the top left corner.

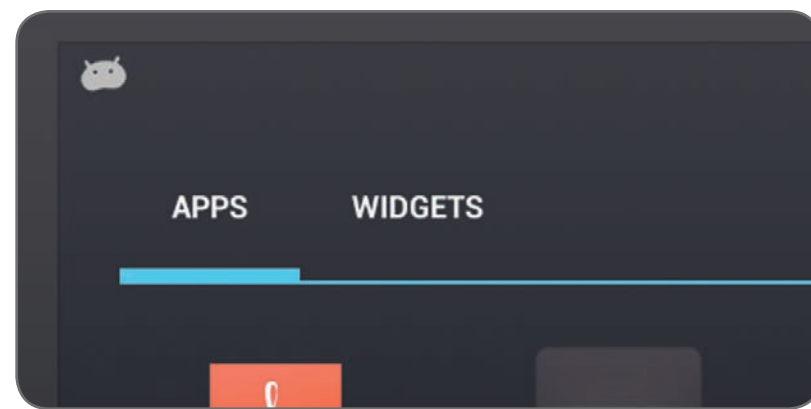

The Widgets page will be displayed.

- 3 Swipe left to see the next page of widgets.

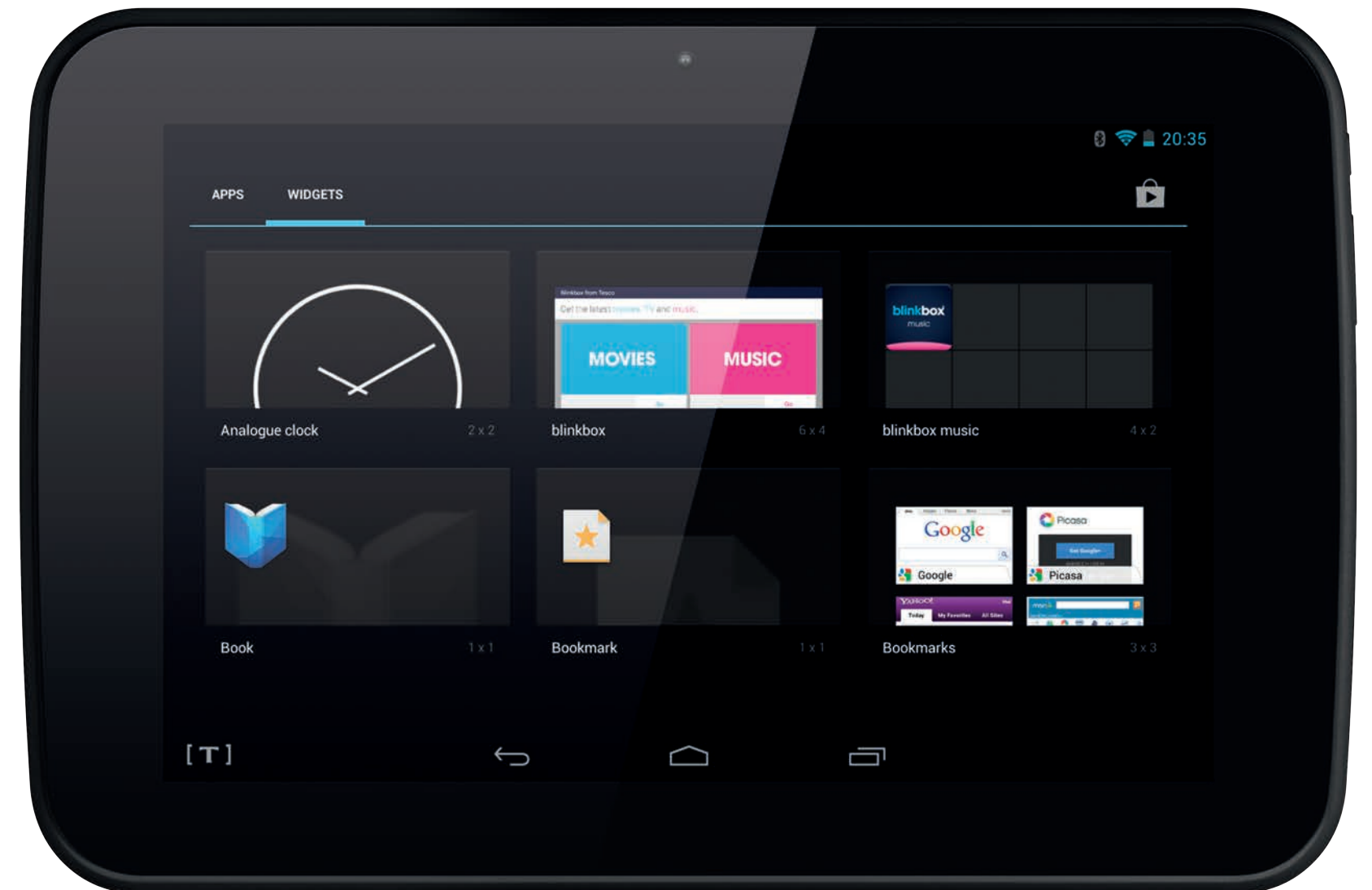

Widgets

Adding a widget to your Home page

If you find one or more widgets that you like, you can add them to your home page.

- 1 Navigate to widget you want to add.
- 2 Touch and hold the widget.

You will be taken to the Home page where you can choose the widgets new position.

The widget is now in place and functioning on the Home Page.

Moving widgets around your Home page

- 1 Touch and hold the widget.
- 2 Drag the widget to a new position.

Note If you drag a widget beyond the Home page, another page will be revealed.

Removing widgets from your Home page

- 1 Touch and hold the widget.
- 2 Drag the widget to the ✕ that appears at the top left of the screen.

The widget will be removed from the Home Page.

Browsing the Internet

The apps installed on Hudl include Google Chrome for browsing the Internet.

Note You will require to be connected to Wi-Fi to browse the internet.

New tab

Current tab

Search and address box

Bookmark this page

Google voice search

Options

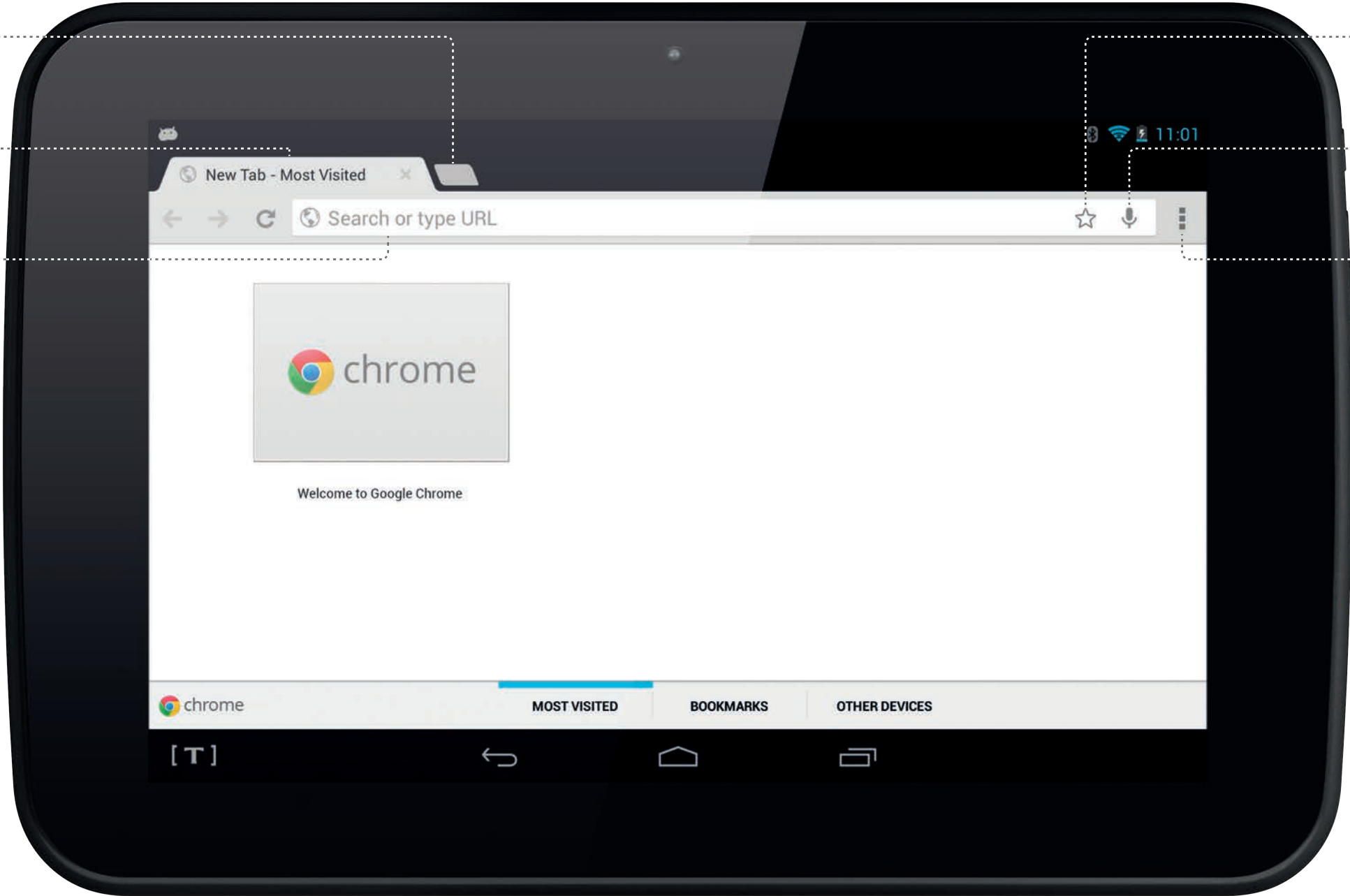

Browsing the Internet

Searching for a subject of interest

- 1 Navigate to the Home page.
- 2 Touch the Google Chrome app icon.
Google Chrome will launch.
- 3 Touch the Search bar.
A keyboard will be displayed.
- 4 Type in your search query on the keyboard.
- 5 Touch **Go** on the keyboard to start the search.
The search results will be displayed.
- 6 Click on a search result to visit the website.
The website will be displayed.
- 7 Click links within the website to explore further into the site.

Entering a web address/URL directly

- 1 Navigate to the Home Page.
- 2 Touch the Google Chrome app icon.
Google Chrome will launch.
- 3 Touch the Search bar.
A keyboard will be displayed.
- 4 Using the keyboard, enter the URL of the website you want to visit.
- 5 Touch **Go** on the keyboard to start the search.
The browser will navigate directly to the website you have entered.

Remember You can zoom in and pan around a web page to read small print or view detail of a picture on a website.

Browsing the Internet

Stepping back through your browsing history

- To step back through pages you have recently visited, touch Back  in the toolbar at the bottom of the screen.

The browser will step back through your recent browsing history one page at a time.

Managing multiple web pages/tabs

The browser includes a tab feature to allow multiple web pages to be open at once.

- 1 To open another browser window, touch the New page tab visible in the browser header bar.
Another page will open.
- 2 You can now run a separate, new search without affecting the results of your current search.

When multiple search tabs are open

- 3 You can switch between active pages by touching the tabs at the top of the screen.
- 4 You can close a page by pressing the ✕ next to the address in the tab.

YouTube and social networking

YouTube

Hudl is bundled with a You Tube app. This allows you to search for video content and also to upload content you film.

Social networking

You can browse to your favourite social networking websites by launching Google Chrome, navigating to the site of your choice and creating or logging in to your account.

Some social networking sites may also have apps available. Check by visiting the Google Play store and searching for the app you want.

Email

To use email you will need to set up your email account on Hudl.

Once your email account is set up you can send and receive email to the contacts you choose.

You can set up and use one or more email accounts from Hudl.

You will always need to have a Wi-Fi connection to set up or use email.

Email

I already have an email account

Most users will have an existing email account when setting up an Internet connection at home.

If this is not the case you may also have created a Google identity for the Google Play store which comes with a 'gmail.com' email address.

Either of the above email addresses will be suitable to set up an email account.

You will need to know the email address and login password for your account before starting.

I don't have an email account

If you don't have an email account, you can browse the Internet to find a suitable email service provider and set up an account. Once you have set up your email account you will have an email address and login password.

You can then follow the instructions to set email up on Hudl.

Setting up an email account

- 1 From the Home Page.
- 2 Touch the Email app icon.
- 3 If an email account has not been set up yet, the Account setup screen will appear.
- 4 Enter your email address as requested. Ensure that all characters are entered correctly and that you are not using capital letters.
- 5 Press **Next** on the keyboard when you are ready. *The cursor will move to the Password line.*
- 6 Enter the password. Make sure that capital letters and numbers are entered correctly.
- 7 Press **Done** on the keyboard. *You can now touch **Manual setup** to choose to set up your email account manually or touch **Next** to set the account up automatically.*
- 8 For automatic setup, touch **Next**. *Hudl will now check the settings. If the server settings are correct, you will see the Account options screen.*
- 9 Set the options as you want them.
- 10 Touch **Next** to continue. *If the outgoing server settings are correct an options screen for the new account will appear.*
- 11 Set the options as you would like them and touch **Next** when you are ready. *The final setup screen is shown with options you can choose for account naming.*
- 12 Correct these details if necessary and touch **Next** when you are ready. *You will be taken to the Email app screen that displays messages in your Inbox and where you compose new messages.*

Email

If your login or server settings are found to be incorrect

- 1 Check and re-enter the details you have used when prompted.

If you receive the same message a second time, there is no point to continue setting up the account as your login details may not be right.

- 2 Make a note of the information reported as incorrect, then contact your email service provider and ask them to send you login or server details that will enable you to set up your account. If the problem reported is server setup, you may find these details on your email service provider's website.

Sending and receiving email

Once you have set up your email account you are ready to receive or send email.

- 1 Navigate to the Home Page.
- 2 Touch the Email app icon. *If your email accounts are live you will now see the email Inbox summary of messages you have received.*

Reading a message

- Touch the message you want to read in the message list. *The message will open.*

Sending a message

- 1 Touch the New message icon. *Fill in the recipients, subject and message text.*
- 2 Touch the **SEND** icon at the top of the screen when your message is ready to go.

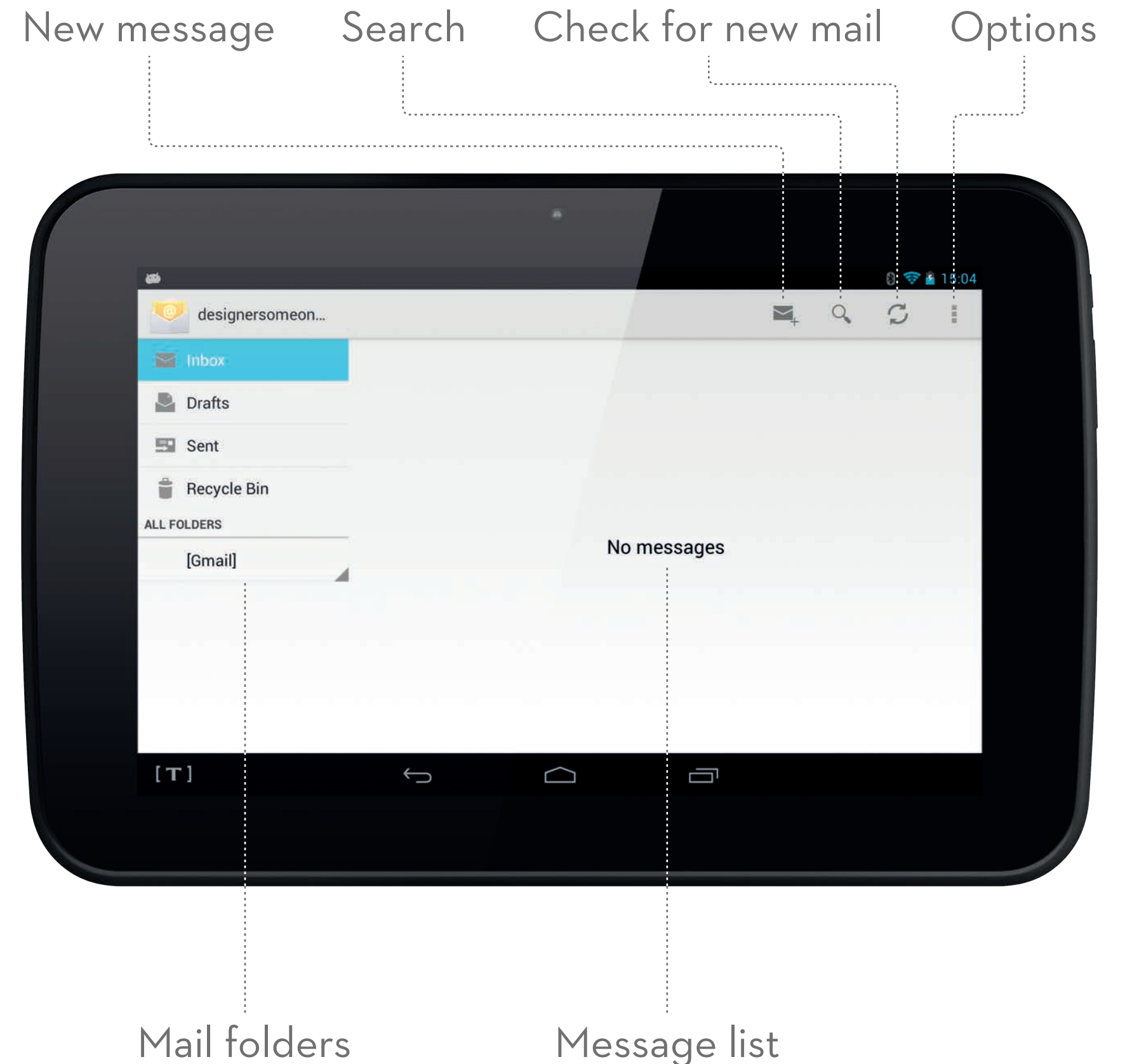

Email

Setting up your email app

- 1 Touch the email settings icon  to access email settings.
- 2 Follow the screen prompts to open general email settings or email settings for a specific email account.
- 3 Each setting includes a brief explanation of what you can change.

Manual send and receive

Your email app will automatically check for new email on a regular basis. The factory setting is 15 minutes. You can change this time in your email settings if required. You can also check for new email manually at any time.

- Touch the Send and Receive icon .

The Email app will check for email.

The Tesco app

Hudl includes a special app to give you fast access to the Tesco services you use regularly.

- 1 Touch the Tesco app icon.

The app will launch.

- 2 Browse up or down the page to view the Tesco services accessible through the app.

Order groceries, find recipe inspiration, manage your Clubcard, shop with Tesco Direct or F&F Clothing, check out the offers and services from Tesco Bank, browse blinkbox movies and music, and find your local Tesco all in one app.

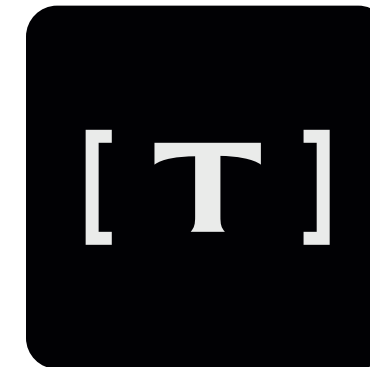

Using the camera

Dual cameras

Hudl has two cameras, one on the back panel and one forward-facing positioned above the screen.

Both cameras can be used for taking photos. The screen mounted camera can also be used for video phone calls and messaging (suitable applications will be required).

Starting the camera application

- 1 Navigate to the Home Page.
- 2 Touch the Camera icon.

The camera application will open.

The display will show the photo you are about to take, there are also icons to change the camera mode or to open the camera settings.

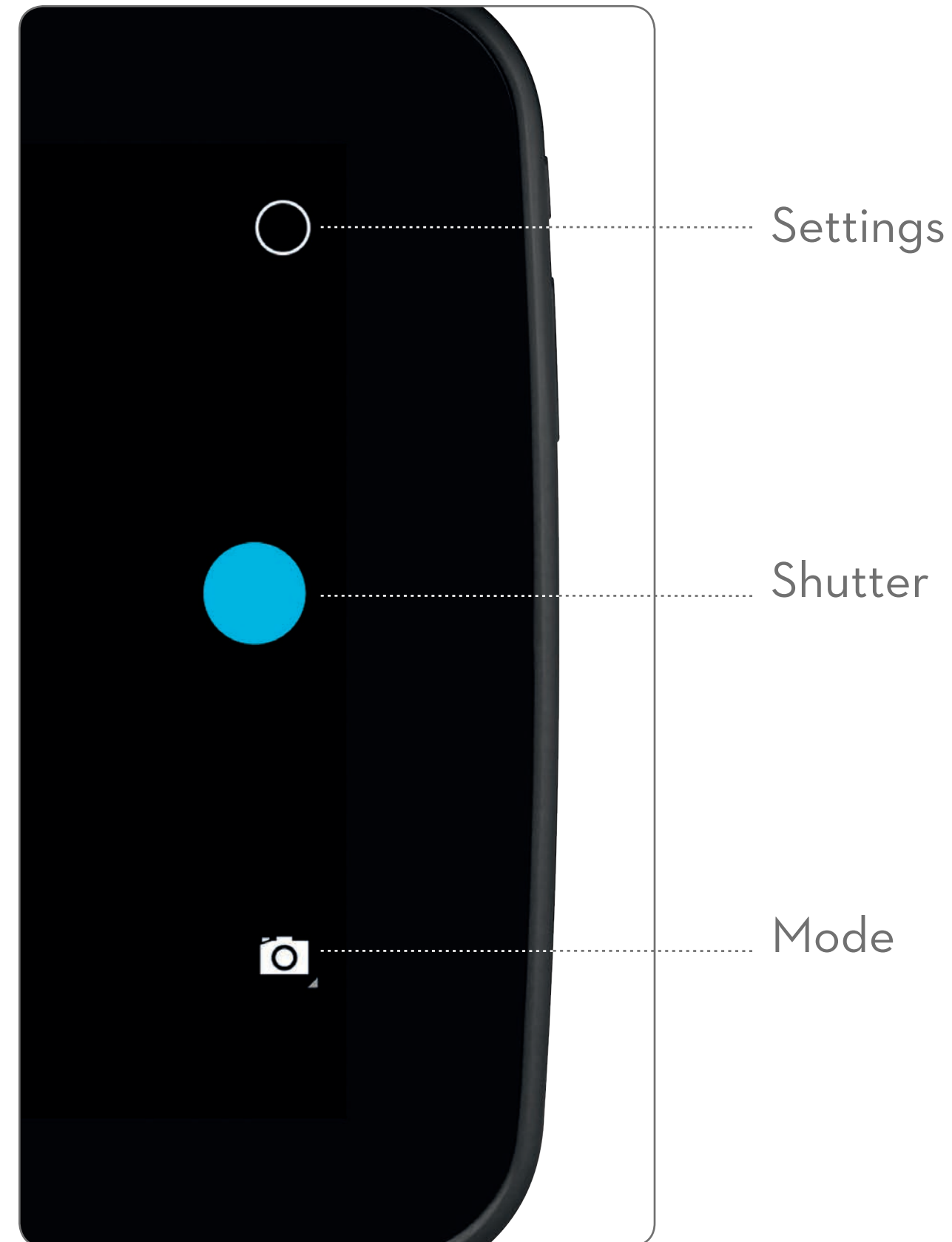

Selecting the camera mode

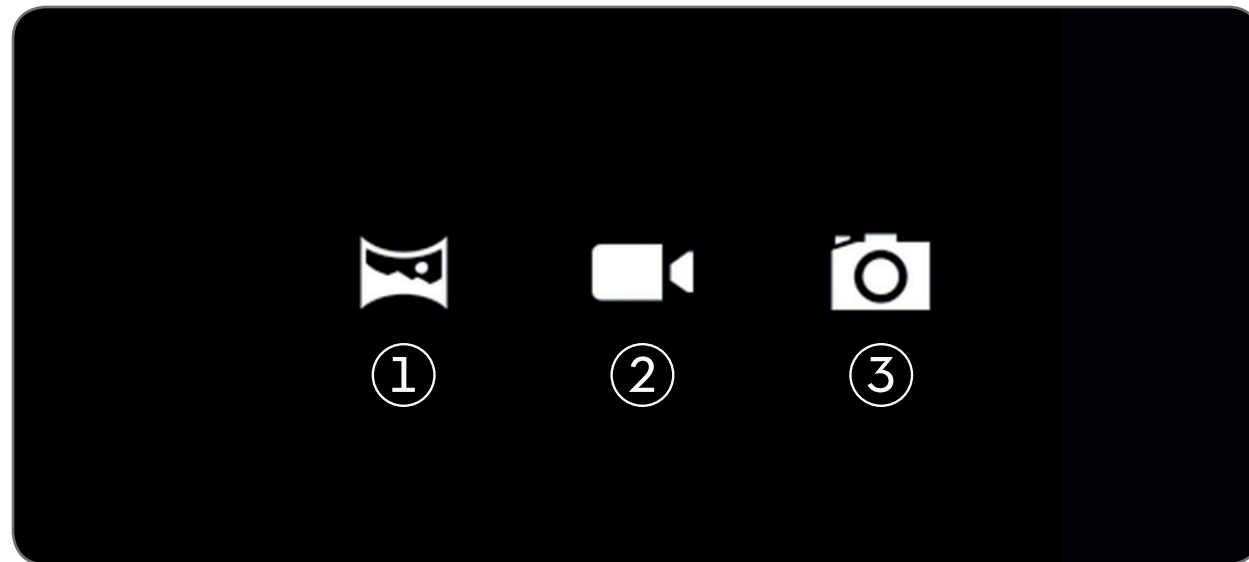

Touch the Mode icon to display mode options.

- 1 Panorama
In Panorama mode the shutter button is blue.
- 2 Video
In Video mode the shutter button is red.
- 3 Still photo
In Still mode the shutter button is blue.

Taking still photos

You will always get a better photo if you set up the camera carefully before taking the photo.

- 1 Rotate Hudl into portrait or landscape orientation to best fit the photo you are taking.
- 2 Zoom to fit the picture by stretching or pinching with your fingers on the screen.
- 3 Hold steady and level. Making sure your fingers are clear of the lens on the back cover, touch the shutter button to take the photo.
The photo will be taken.

Manual focus

To focus on a particular subject when taking a photo, touch the subject on the screen display. *A ring will appear and the lens will refocus to that area.*

Changing camera settings

Touch the Camera settings icon .



1 Camera Selector

Touch the camera selector icon to switch from the back camera to the screen camera. *The screen view will switch between cameras.*

2 Exposure

Touch the Exposure icon to change the exposure settings.

3 Settings

Touch the Settings icon to choose a Storage location or to change the Picture size.

Note

Choosing a larger picture size will increase the quality of your pictures. Choosing a smaller picture size will allow you to store more pictures on your Hudl or a docked micro-SD card.

4 White Balance

Touch the White balance icon. *The white balance options will be displayed.*

Choose from cloudy, sunny, automatic, indoor fluorescent or indoor tungsten bulb. Automatic is the recommended setting.

Using the camera

Taking a panorama photo

A Panorama photo will capture a very wide angle, allowing you to swing the camera slowly as the photo is composed.



- 1 Open the camera application.
- 2 Touch the Panorama mode icon.
- 3 Set the camera view at the left of the image you want to capture.
- 4 When you are ready to take the photo, press the shutter button.
- 5 Holding steadily at a constant height, watch the screen and rotate your position slowly and steadily to the right to capture the panorama.

Note

If you move too quickly, a red border will appear around the screen with the legend 'too fast'. Adjust your speed accordingly.

The panorama indicator will show when the full panorama has been captured.

Using the camera

Making a video

1 Open the camera application.



2 Set to Video mode.

The shutter button will change to red.

3 Zoom to fit the picture by stretching or pinching with your fingers on the screen.

4 Hold steady and level. Making sure your fingers are clear of the lens on the back cover, touch the shutter button to start recording.

Video and sound will start recording.

5 Touch the shutter button again to stop recording.

You can also change settings for videos.

The Camera selector and White balance settings are set in the same way as a still photo.

- Touch the Settings icon  to choose a Storage location or to set up time lapse recording.

Time-lapse recording

If time-lapse recording is set, the camera will repeatedly take a still photo at a time interval that you choose.

1 From Settings, set the time-lapse option to 

2 Now select a time interval for your time-lapse.

3 When you are ready to go, touch the shutter.

Photos will be taken at the interval you set.

Clock application

You can use the clock app to display the time in large format on the screen.

The clock app includes

- A large format display of the time.
- A timer to count down from a time you program.
- A stopwatch that can time multiple events.
- An alarm clock that can be programmed with multiple wake-up times.

To use the clock app

- Touch the Clock application. 

The screen will show a large format clock (digital or analogue may be selected in settings).

- | | | | |
|---|--------------------|---|----------------|
| ① | Timer icon | ⑤ | Day and date |
| ② | Clock icon | ⑥ | Alarm icon |
| ③ | Stopwatch icon | ⑦ | Time zone icon |
| ④ | Large format clock | ⑧ | Settings icon |

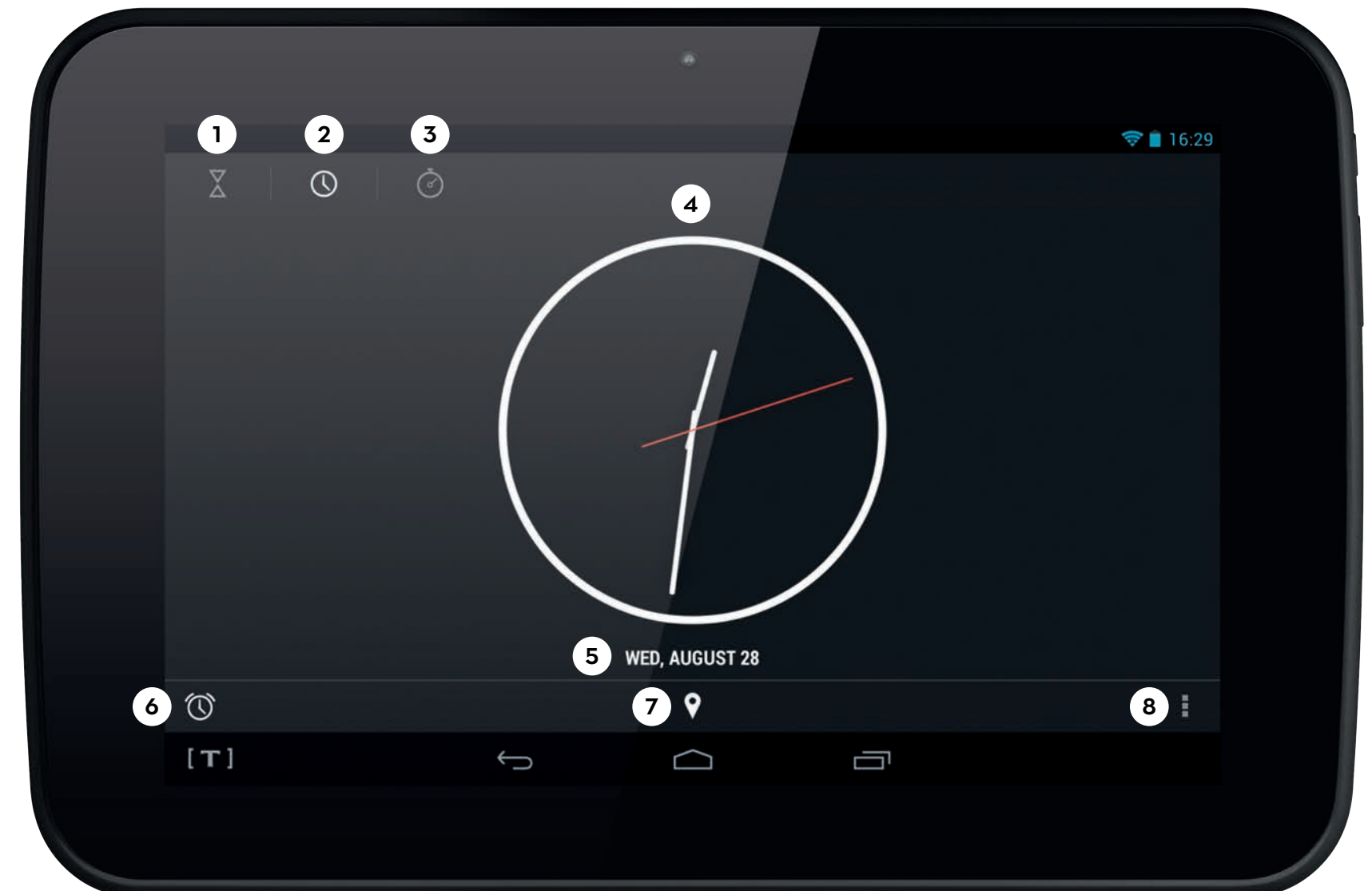

Clock application

Clock application during sleep

The clock application will continue to run whilst Hudl sleeps.

When your Hudl is battery powered, the display will switch off and conserve battery life. If the charger is connected, the display will stay lit so you can continue to see the clock display.

Clock application settings

You can personalise the appearance and other settings for the clock application.

- Touch  to customise your clock settings.

The clock settings screen will open.

Choose from digital or analogue clock displays, set your time zone and set up the alarm to your preferences.

Clock application

Using the timer

- 1 Touch the Timer icon on the clock display.
- 2 Enter the time you want with the numeric keys that are displayed.
- 3 Touch **START** to start the timer.

The timer will start to countdown.

When the time has elapsed, the alarm will beep to alert you.

Using the Stopwatch

- 1 Touch the Stopwatch icon on the clock display.
- 2 Touch **START** to start the stopwatch.

The stopwatch will start.

- 3 Touch **STOP** at any time to stop the stopwatch.

The stopwatch will pause.



- 4 Touch **START** again if you want to re-start the stopwatch.

Multiple stopwatch events:

- Touch the Event icon  to stop the stopwatch and begin timing a second event. *The time for the first event will be displayed, and the timer will begin to time the second event immediately.*

Clock application

Using the alarms

- 1 Launch the clock application. 
- 2 Touch the alarm icon  on the clock display.

The Alarms pane will open.

Alarms that are currently set will be displayed.

In the example shown there are two alarms set.

The alarms will still sound if you are using other applications on your Hudl, so you can use the alarm to remind you of appointments, meetings etc. while you are working.

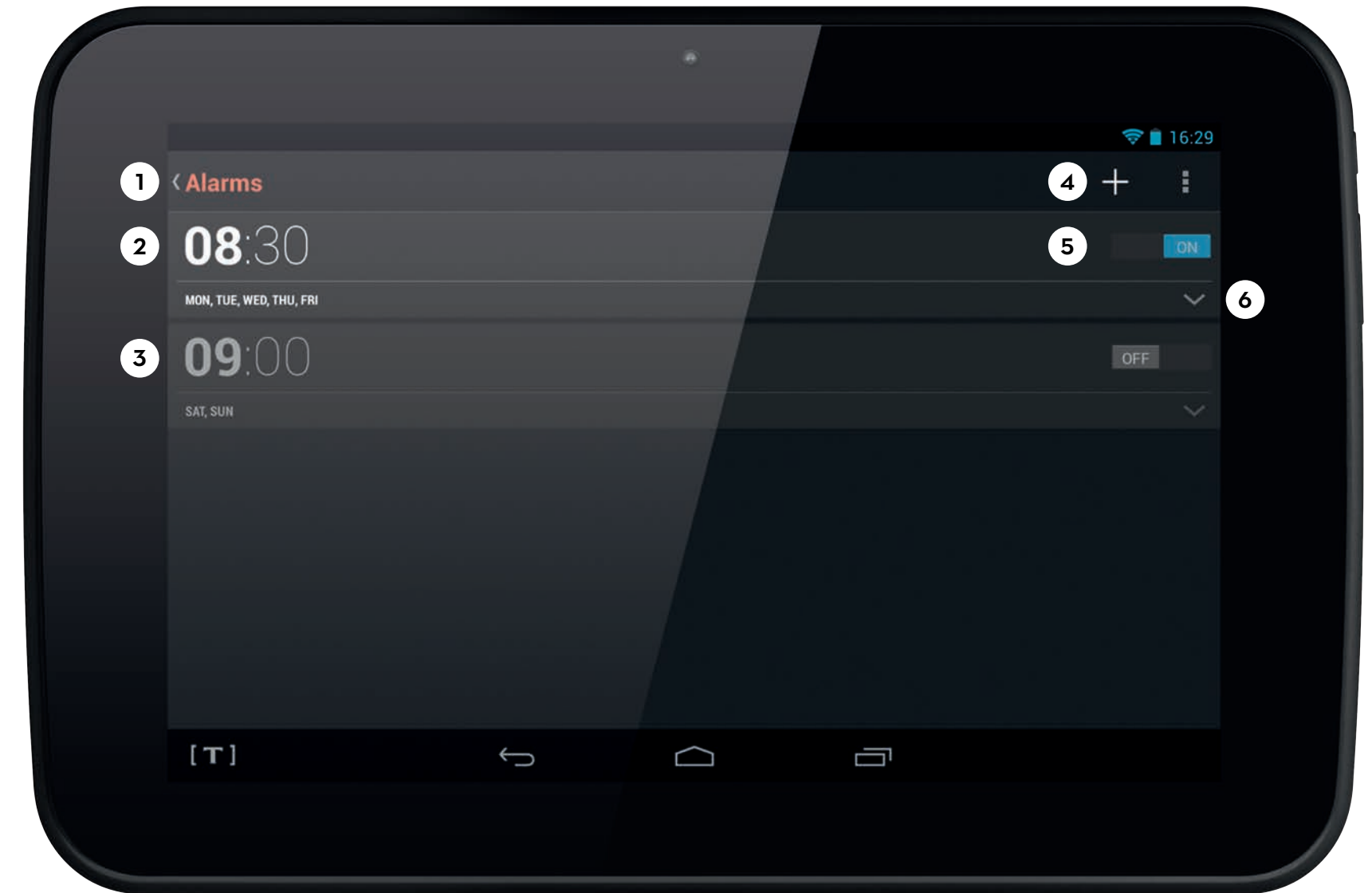

- | | | | |
|---|-----------------------|---|-----------------------|
| ① | Exit the alarm screen | ④ | New alarm time |
| ② | Alarm 1 time | ⑤ | Activate alarm |
| ③ | Alarm 2 time | ⑥ | Expand alarm settings |

Clock application

Adding an alarm setting

- 1 Touch the New alarm icon  to add another alarm setting.

A number pad will be displayed.

- 2 Enter the alarm time using the number pad.

- 3 Touch **OK** when you're ready.

The expanded alarm settings will be displayed.

- 4 Touch **Label** to type in a name for this alarm.

- 5 Touch **REPEAT** to set when you want the alarm to sound.

The default is every day. You can touch days to remove them from the repeat list.

- 6 Touch the Alarm tone icon  to choose a tone for this alarm.

- 7 Touch  to close the detail view for this alarm when you have finished.

Clock application

When an alarm sounds

The time will be displayed and the alarm sounding icon will flash.

- Touch the alarm icon and drag to the Alarm off icon or Snooze icon.

If you choose 'Alarm off' the alarm will reset until the next alarm time.

If you choose the Snooze option, the alarm will sound again within 10 minutes.

- ① Alarm off
- ② Alarm sounding
- ③ Snooze

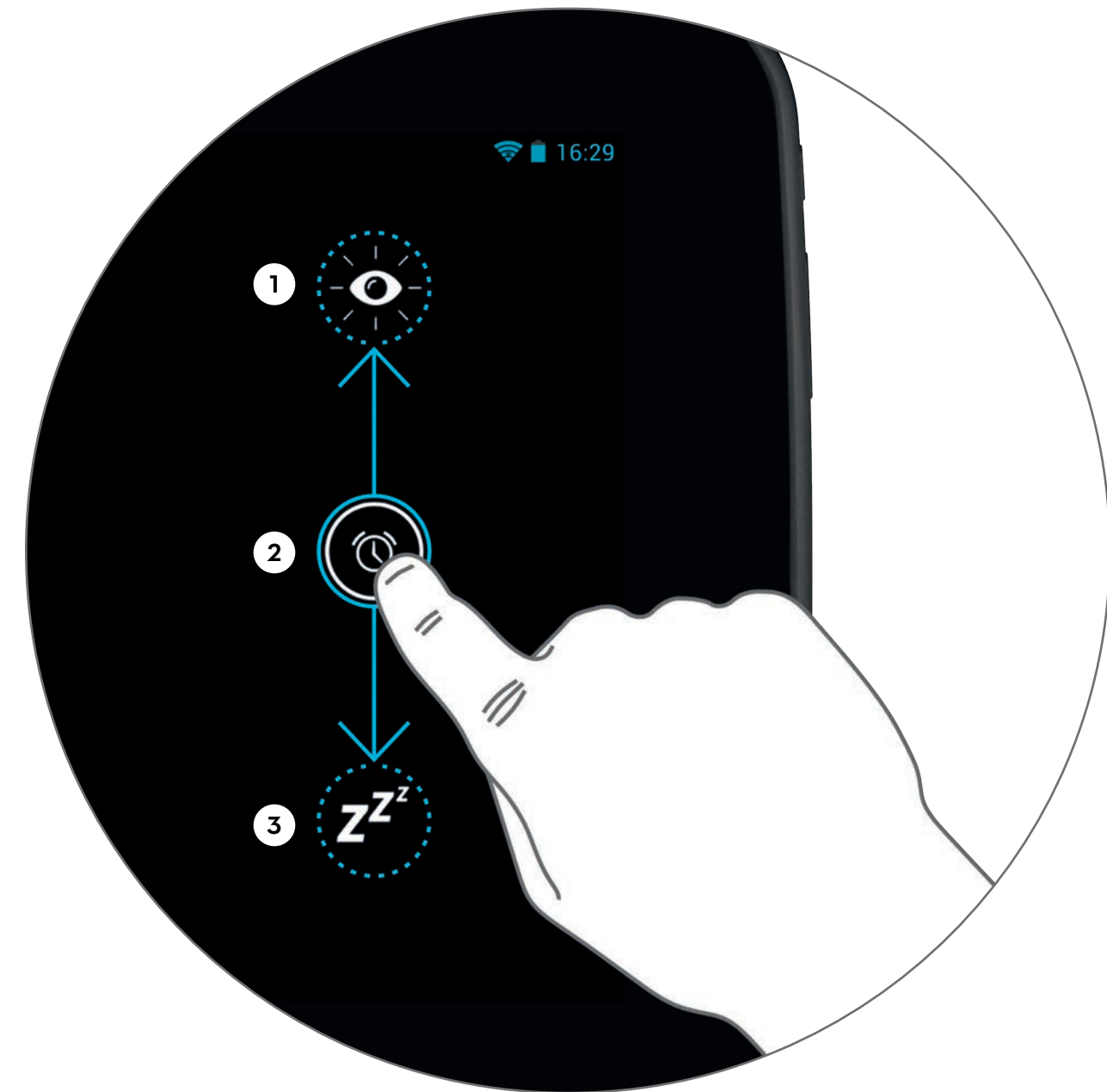

Music, photos and video

You can play compatible music files, browse digital photos and watch video files on your Hudl.

You can choose to buy music or movie files from an online store, you can transfer compatible files from your computer or you can dock a micro-SD card pre-loaded with files.

Transferring files using Windows Explorer

For users familiar with computer file transfer, Windows Explorer can be used to transfer media files or folders to or from your Hudl. Windows Explorer is also used to transfer other files such as documents, spreadsheets and ebooks.

- 1 Switch on the computer.
- 2 Open a file browser on your computer.
In Windows XP, navigate to 'My Computer' (Click Start>My Computer). In Windows 7, navigate to 'Computer' (Click the Windows logo> Computer)
- 3 Connect the USB cable (supplied) to the USB connector on your Hudl.
- 4 Connect the other end of the cable to a convenient USB port on your computer.
- 5 On your computer, browse to the list of drives. You will see your Hudl in the drive list.

Note

When a micro-SD card is docked to expand the memory, this will appear as a separate drive. Double click to open the Hudl drive and you will see a group of folders.

Some of these hold media and other data such as:

- A Music (for uploading music).
- B Pictures (for digital photos).
- C Movies (for videos and movies).
- 7 DCIM (for photos and videos taken by the built-in camera).
- 8 Open a second window of 'My Computer'.

Transferring files using Windows Explorer

Uploading files/folders

- 1 Browse to the folders or files you want to copy from your computer and drag them onto a folder to upload them.

In the example, music albums are being dragged onto the Music folder on Hudl. The process is the same for other types of file, but the destination folder will be different.

- 2 You can also drag files the other way to copy your photos and videos etc. from Hudl back to a folder on your computer.

Note Music files must be in MP3, WAV, APE, OGG or FLAC format, videos must be in AVI, MP4, MKV, MOV or FLV format and photo files must be in JPG, BMP, GIF or PNG format.

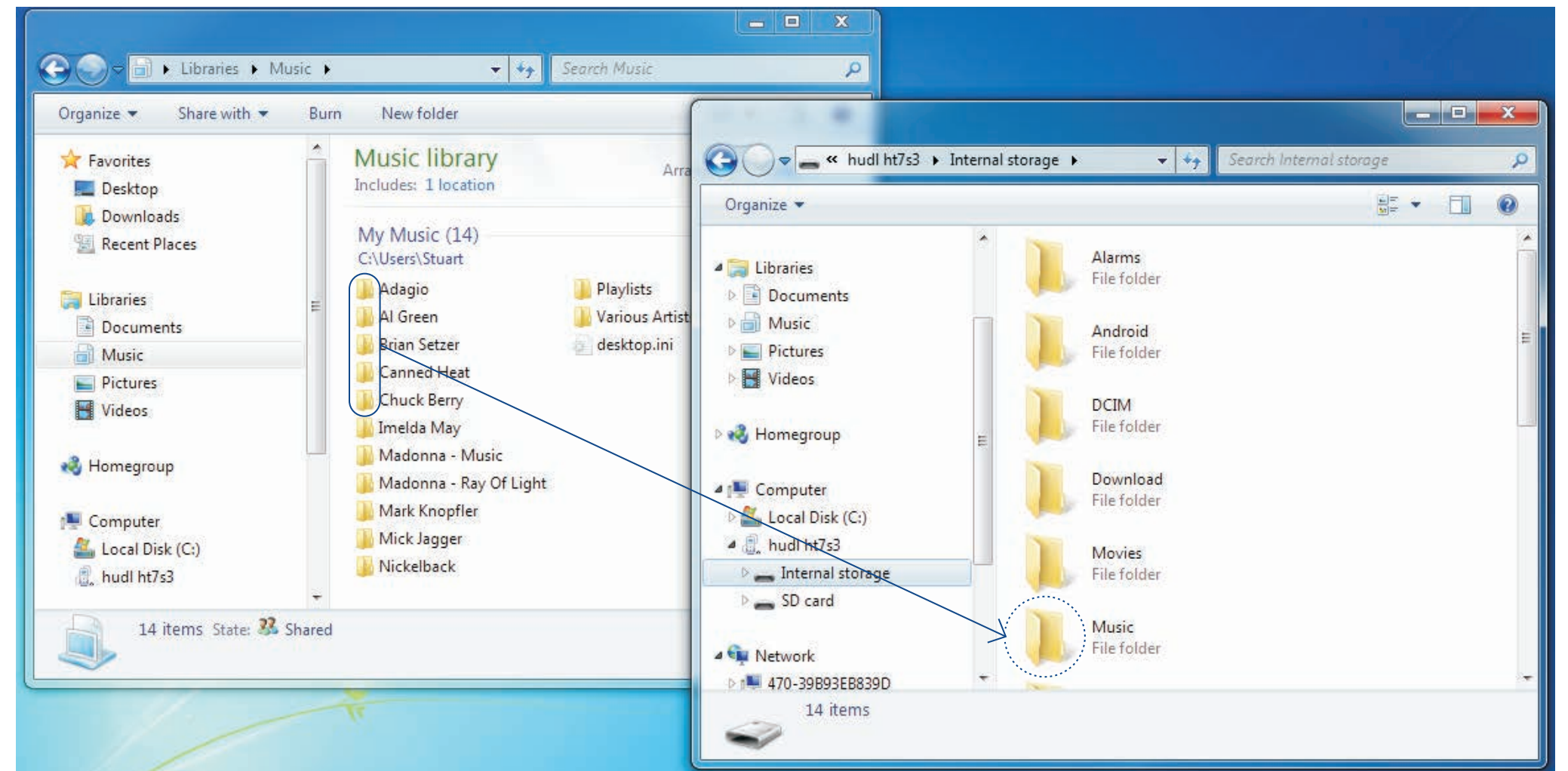

Transferring files using Windows Explorer

Managing folders and files from your computer



- 1 You can create new folders on Hudl to organise your documents, spreadsheets etc., just as you would on your computer.

Once you have created the folders you need you can copy your files to them.

- 2 You can also delete files or move files between the internal memory and a docked micro-SD card.

Playing Music

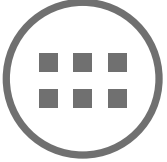
Once you have downloaded some music files from the store or uploaded some from your computer, they will be available to play.

- 1 Navigate to the All applications screen. 
- 2 Touch the 'Play Music' icon. 
- 3 On first use you will be invited to set up a Google Play account. When you have completed this stage, the Music index screen will open.

You can now choose to browse your music library or playlists, choose albums or tracks from the library and play them.

Note The music library will only display music albums and tracks that are in one of the compatible, playable formats of MP3, WAV, APE, OGG or FLAC.

Viewing your photos and videos

You can use the Gallery app to watch photos and videos filmed with the camera or copied from your computer.

- 1 Touch the 'Gallery' icon. 

The Gallery screen will open. The screen will show you albums available including photos and videos taken by the built-in camera, those in the internal memory and those on a micro-SD card (when fitted).

- 2 Touch an album to browse photos and videos stored in the album.

- 3 The photos will be displayed as a screen of thumbnails. If there are several screens of thumbnails you can slide them across to browse them.

Videos will be identified by a Play icon  in the centre of the image.

Viewing photos or videos full-screen

- Touch a thumbnail to view a photo or video full-screen. You can browse the photos or videos in the album by sliding them to the left or right.

Playing a video

- Press the Play icon  in the centre of the image to start a video playing.

Viewing your photos and videos

Photo toolbar

- Touch a full-screen photo or video to reveal a toolbar at the top of the screen and a hot-link photo edit icon  at bottom left.

Sharing photos and videos

- Touch the share icon  in the toolbar to share this photo or video with friends.

From the share pane you can choose to email the photo/video or to share it via social networking.

Additional options

- Touch the settings icon  in the toolbar to see additional options.

From the drop-down menu you can delete a photo, start a slideshow, edit a photo, rotate a photo on-screen or crop a photo.

Some additional options are also available for videos.

Backing up your data

Data loss



Your data may be valuable to you. Always keep a backup copy of critical data such as photos, videos and documents.

You can back up your data using an online cloud-based service or by periodically copying critical files to your computer.

Device settings > Overview

The settings screens enable you to set up and personalise Hudl to your own requirements.

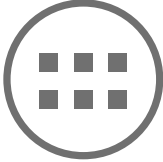
Opening the Settings screen

- 1 Touch the All Applications icon. 
- 2 Touch the Settings icon. 

The Settings screen will open. More settings are available by dragging the index up or down.

- 3 Touch the setting you want to change in the setting index on the left of the screen.

The options for this setting will be shown.

- 4 Follow the on-screen prompts to change options to your requirements.

The following pages include more information about each group of settings.

Device settings > Wireless and networks

Wireless & Networks > Wi-Fi

Touch this option to see if your Hudl is connected to a wireless network and also to see any other wireless networks that will connect when you are within range of them.

- Touch the ON/OFF button  on the Wi-Fi tab to switch wireless networking on or off.

To join a network in the list



- Touch the name of a network in the list to join the network.

If the network is secure, you will be asked for the password.

To join a wireless network that has WPS wireless protection:

- 1 Touch the  icon to start a search for a WPS protected network.
- 2 Follow the prompts to connect to the network.

The toolbar includes some additional options

- 1 Touch  in the toolbar to manually enter the details for a wireless network.
- 2 Touch the settings icon  to open the Advanced settings pane.

Here there are more settings to change the way your Hudl interacts with wireless networks.

Device settings > Wireless and networks

Wireless & Networks > Bluetooth

Bluetooth communication can be used to connect wireless Bluetooth accessories, such as speakers, or to communicate with another Bluetooth device for media transfer etc.

The recommended setting is OFF  unless you want to pair to Bluetooth accessories or to communicate to another Bluetooth device for media transfer etc.

To pair with a Bluetooth device

- 1 Set Bluetooth  in the toolbar.
- 2 Set the other Bluetooth device to be discoverable.
- 3 Touch **'SEARCH FOR DEVICES'**.

*Hudl will scan for any devices in range and list them under **'PAIRED DEVICES'**.*

- 4 Touch the device name in the list to pair with it.

You can now use the paired accessory or transfer media to a paired device.

Device settings > Device

Device > Sound

Touch this option to set up sound volumes and to enable/ disable system sounds.

Device > Display

- Touch this option to change the display settings.

On this screen you can set the brightness, change the background wallpaper, set the auto-sleep time or change the default font size. You can also enable connectivity for a wireless display.

Device > HDMI

- Touch this option to change the settings for a connected HDMI TV or monitor.

These settings will not affect the main display.

Device > Storage

- Touch to view a breakdown of the usage of internal memory and a docked micro-SD card (when fitted). DEVICE > Storage > SD CARD > Unmount SD card

- Navigate to this option if you want to remove the SD card.

Once the card has been unmounted you can safely remove it.

Device > Battery

- Touch to see the charge status of the battery.

An estimate of battery life remaining and an illustration of battery usage are also displayed.

- Touch one of the items to view detail.

Device settings > Device

Device > Apps

- Touch this option to view a breakdown of the Applications installed, and the memory space that they occupy.

Touch one of the apps to see more information about the app and also any settings that may be changed.

Device > Users

- Touch to view a list of registered users.
- Touch **ADD USER** to add a new user.

Each user can personalise their apps, wallpaper and data.

If multiple users are set, you can choose your user name as you switch on.

Device settings > Personal

Personal > Location Access

- Touch this option to enable or disable notification of your location to Google. Location details are used in navigation apps or to improve search results and other services that depend on location.

Personal > Security

This section of settings enables you to set your security preferences.

Personal > Security > Screen Security

- Touch this tab to enable/disable a security method that will be needed to unlock the screen when switched on.

You can choose your method of security and enter the details.

Caution Don't forget to make a note of the security you put in place!

Personal > Language & Input

- Touch this tab to change language, spelling and keyboard options. You can also enable/disable speech-to-text.

Device settings > Personal

Personal > Backup & Reset

- Touch this tab to change options for backup and restore of your application data, also to erase all personal data.

Personal > Backup & Reset > Backup & Restore

If you check the Back up my data option, your application data, Wi-Fi passwords and settings will be backed up to Google's servers.

You can also choose to restore application data.

Personal > Backup & Reset > Personal Data

- Touch the Factory data reset tab to erase all data from the internal memory.

This will include: Google accounts, System and app data and settings, downloaded apps, music and photos.

Caution This operation cannot be undone.

Device settings > Accounts

Accounts > Email

- Touch this tab to change settings for the email accounts you use.

Accounts > Google

- Touch this tab to change settings for the Google accounts you use.

Accounts > + Add Account

- Touch this tab to create a new account.

The next pane will enable you to choose the type of account you want to set up.

- Follow the screen prompts to set up the account of your choice.

Device settings > System

System > Date & Time

- Touch this tab to set the time or to choose manual time setting and set the clock.

System > Accessibility

- Touch this tab to personalise accessibility settings to make Hudl easier to use.

System > About Tablet

- Touch to open a screen which will display information about the hardware and firmware.

From this screen you can also check for firmware updates.

Connecting accessories

HDMI display port. You can connect a TV or display monitor to the HDMI port.

You will need a cable (not supplied), terminated with a micro-HDMI connector at one end and a connector suitable for your TV at the other.

- 1 Connect the micro-HDMI cable to the port on the top of Hudl.
- 2 Connect the other end of the cable to the TV/monitor. The TV/Monitor should auto-select the signal from Hudl and switch to display the screen content. If not, you will need to select the correct input manually.

Caution To avoid damage and tripping, take care to keep the HDMI cable away from walkways, children and pets when the cable is connected.

HDMI settings

If necessary, you can customise the HDMI settings to best match your TV. Refer to Device Settings > Device > HDMI on page 68 for more information.

Bluetooth accessories

You can also connect compatible Bluetooth accessories such as speakers, keyboards and mice.

- 1 Check that the accessory is suitable for use with an Android tablet.

You will need to pair the accessory with Hudl before using it.

- 2 Refer to Device Settings > Wireless & Networks > Bluetooth on page 74 for more information about Bluetooth pairing.

Troubleshooting

Unable to browse the Internet or send/receive email

- 1 Go to Settings > Wireless & networks.
- 2 Check that Wi-Fi is switched on in the Wi-Fi tab.
- 3 Check that there is a wireless network connected (wireless networks will be listed in the information pane).

If your network is not in the list, it may be out of wireless range.

- 4 Move closer to the network hub and re-try.

If the wireless network is connected, but the Internet is not accessible, it may be that the network is not connecting to the Internet.

- 5 Connect a computer to the network and try connecting this to the Internet.

If the computer will not connect you may need to enlist the help of an IT professional to check the network.

Unable to use Bluetooth accessories

Check that the accessory is compatible with an Android device.

Refer to Settings > Wireless & Networks > Bluetooth to check that the Bluetooth is switched on and that the accessory has paired correctly with Hudl.

Troubleshooting

Unable to play some music, photo or movie files

Music files of incompatible formats will not be visible when you browse to play music, photos or videos.

- Check that the files you have transferred are compatible with Hudl.

There is a list of compatible formats in the specifications section.

Unable to use applications that require your location
Location services may not be switched on.

- 1 Go to Settings > PERSONAL > Location access.
- 2 Enable the location services you require.

Unable to access a micro-SD card memory
The micro-SD card may not be fully inserted.

- 1 Switch off the power.
- 2 Remove the micro-SD card and re-insert it.
- 3 Switch on the power.
- 4 Check if the card is accessible.

If the card is still not accessible, it may be faulty.

- 5 Check the card by reading it with a computer.

Strange behaviour

- Power off fully, wait 15 seconds and switch on again.

Specifications

Charger supply rating	100–240 v~, 50/60 Hz, 0.5 A	Memory card	Micro-USB up to 32GB
Charger output rating	5v, 2A	External display	HDMI
Screen size, resolution	7", 1440 x 900 pixels	Weight	370g
Camera resolution	3MP Autofocus	Music	MP3, WAV, APE, OGG, FLAC
Screen camera resolution	2MP Fixed focus	Video	AVI, MP4, MKV, MOV, FLV
Internal memory	16GB	Photo	JPG, BMP, GIF, PNG
Wi-fi compatibility	Wi-Fi 802.11 a/b/g/n		
Bluetooth version	4.0		
Data/charger connection	Micro-USB		



For further reference
please visit [tesco.com/hudl](https://www.tesco.com/hudl)